



## **Concrete Admixtures** ■ - - - - -

Concrete Plasticizers  
Concrete Superplasticizers  
Concrete Hiperplasticizers  
Set-Control Additives

Internal Waterproofings  
viscosity modifier additive  
Air Entraining Agents

## **Construction Chemicals** ■ - - - - -

Groutings

Surface Waterproofing  
Concrete Surface Repairs

## **Sealing Tapes** ■ - - - - -

P.V.C Waterstops  
Hydrophilic Waterstops

## **Concrete Plastic Accessories** ■ - - - - -

Plastic Spacers

# Concrete Admixtures

Concrete Plasticizers

Concrete Superplasticizers

Concrete Hiperplasticizers

Set-Control Additives

Pozzolanic Products

Internal Waterproofings

Viscosity Modifier Additive

Air Entraining Agents



# Plastit<sup>®</sup> L1

## Water Reducing Admixture

### Uses

- To improve the effectiveness of the water content of a concrete mix.
- At higher dosages to provide a cost effective means of reducing concrete permeability and thereby reducing water penetration.

### Advantages

- Allows specified strength grades to be met at reduced cement content or increased workability.
- Water reduction significantly improves compressive strengths at all ages and enhances durability through the production of low permeability concrete.
- Minimizes the risk of segregation and bleeding and assists in the production of a dense, close textured surface, improving durability.
- Chloride free, safe for use in prestressed and reinforced concrete.

### Standards compliance

Plastit L1 conforms with BS 5075 Part 1 and with ASTM C494 as Type A.

### Description

Plastit L1 is a chloride free water reducing admixture based on selected sugar-reduced lignosulphonates. It is supplied as a brown solution which instantly disperses in water. Plastit L1 disperses the fine particles in the concrete mix, enabling the water content of the concrete to perform more effectively and improving the consistency of the concrete. This produces higher levels of workability for the same water content, allowing benefits such as water reduction and increased strengths to be taken.

### Typical dosage

The optimum dosage of Plastit L1 to meet specific requirements should always be determined by trials using the materials and conditions that will be experienced in use. The normal dosage range is 0.3 to 0.8 kg/100 kg of cementitious material, including PFA, GGBFS and microsilica.

### Properties

Appearance	Brown Liquid
Specific gravity	1.17 gr/cm <sup>3</sup> at °20C
Chloride	Nil to BS5075
Air entrainment	Typically less than 1/2 additional air is entrained at normal dosages.
Alkali content	Typically less than 5.0 g. Na <sub>2</sub> O equivalent/litre of admixture. A fact sheet on this subject is available.

### Instructions for use

#### Compatibility:

Plastit L1 is compatible with other CAPCO admixtures in the same concrete mix. All admixtures should be added to the concrete separately and must not be premixed together prior to addition. The performance of concrete containing more than one admixture should be assessed by trial mixes.

Plastit L1 is suitable for use with all types of Portland cements, SRC cements and cement replacement materials such as PFA, GGBFS and microsilica.

The use of a combination of admixtures in the same concrete mix and or cement replacements may alter the setting time. Trials should always be conducted to determine such setting times.

#### Dispensing:

The correct quantity of Plastit L1 should be measured by means of a recommended dispenser. The admixture should then be added to the concrete with the mixing water to obtain the best results.

### Packaging

Plastit L1 is available in 20 kg containers and 240 kg drums.

### Storage

Plastit L1 has a minimum shelf life of 12 months provided the temperature is kept within the range of °5C to °35C. Should the temperature of the product fall outside this range then contact CAPCO for advice.

**Freezing point:** Approximately °3-C

### Precautions

#### Health and safety:

Plastit L1 does not fall into the hazard classifications of current regulations. However, it should not be swallowed or allowed to come into contact with skin and eyes.

Suitable protective gloves and goggles should be worn.

Splashes on the skin should be removed with water. In case of contact with eyes rinse immediately with plenty of water and seek medical advice. If swallowed seek medical attention immediately - do not induce vomiting.

#### Fire:

Plastit L1 is non-flammable.

# Plastit<sup>®</sup> L1

## Sample Test Results

Table 1:

Plastit L1 Kg per 100 kg cement	W/C ratio	Air content in fresh concrete (%)	Slump (cm)	Time (day)			
				1	3	7	28
				Compressive strength (MPa)			
0	0.47	1.7	6	3.5	16.7	23.3	33.6
0.5	0.47	1	16	3.7	19.6	30.2	39.3

# Plastit<sup>®</sup> LR

## Retarding, Water Reducing Admixture

### Uses

- To improve the effectiveness of the water content of a concrete mix.
- To help maintain the workability of readymixed concrete deliveries in hot weather.
- To extend working times of concrete.
- Particularly suitable for use in mixes with low cohesion.

### Advantages

- Water reduction significantly improves compressive strengths at all ages and enhances durability.
- Controlled retardation extends working life and stiffening time for ease of construction.
- Control of stiffening improves slip forming and assists in preventing the formation of cold joints in large pours.
- Minimized transportation delay problem maintains place ability and reduces the risk of pump blockage.
- Slight air entrainment improves cohesion in mixes with poorly graded sands or a lack of fine material, minimizing bleed and segregation.
- Allows specified strength grades to be met at reduced cement content or increased workability.
- Chloride free, safe for use in prestressed and reinforced concrete.

### Standards compliance

Plastit LR conforms with BS 5076 Part 1, ASTM C494 as Type B and Type D and BSEN 20674.

### Description

Plastit LR is a chloride free water reducing admixture based on selected lignosulphonate materials. It is supplied as a brown solution which instantly disperses in water. Plastit LR disperses the fine particles in the concrete mix, enabling the water content of the concrete to perform more effectively. The initial hydration of the cement is also delayed, resulting in a delay in the setting time of the concrete with no adverse effect on subsequent stiffening and strength gain.

### Typical dosage

The optimum dosage of Plastit LR to meet specific requirements should always be determined by trials using the materials and conditions that will be experienced in use. The normal dosage range is 0.2 to 0.8 kg/100 kg of cementitious material, including PFA, GGBFS or microsilica.

### Properties

Appearance	Brown Liquid
Specific gravity	1.17 gr/cm <sup>3</sup> at 20°C
Chloride	Nil to BS5076
Air entrainment	Typically less than 1% additional air is entrained at normal dosages.
Alkali content	Typically less than 0.0 g Na <sub>2</sub> O equivalent/litre of admixture. A fact sheet on this subject is available.

### Instructions for use

#### Retardation:

The level of retardation obtained may be varied by altering the dosage of Plastit LR used, which will also alter the level of water reduction obtained. Retardation is also affected by factors other than the admixture, depending on the mix details and conditions involved. Major factors include the following:

- Cement replacement materials and SRC cements will usually give greater levels of retardation than concrete mixes made with ordinary Portland cement at the same admixture dosage.
- High temperatures will require increased dosages to obtain the same change in stiffening time compared to a control mix.
- Changes in cement content, source or chemistry may lead to variations in the retardation obtained. The amount of tri-calcium aluminate in the cement has been identified as being one of the main contributory factors in this respect, with a lower level leading to greater retardation.
- The use of a combination of admixtures in the same concrete mix may alter the setting time. Trials should always be conducted to determine such setting times.

#### Compatibility:

Plastit LR is compatible with other CAPCO admixtures in the same concrete mix. All admixtures should be added to the concrete separately and must not be premixed together prior to addition. The performance of concrete containing more than one admixture should be assessed by trial mixes. Plastit LR is suitable for use with all types of Portland cements, SRC cements and cement replacement materials such as PFA, GGBFS and microsilica.

The use of a combination of admixtures in the same concrete mix and or cement replacements may alter the setting time. Trials should always be conducted to determine such setting times.

#### Dispensing:

The correct quantity of Plastit LR should be measured by means of a recommended dispenser. The admixture should then be added to the concrete with the mixing water to obtain the best results.

### Packaging

Plastit LR is available in 20 kg containers and 250 kg drums.

### Storage

Plastit LR has a minimum shelf life of 12 months provided the temperature is kept within the range of 0°C to 30°C. Should the temperature of the product fall outside this range then contact CAPCO for advice.

**Freezing point:** Approximately 0°C

# Plastit<sup>®</sup> LR

## Retarding, Water Reducing Admixture

### Precautions

#### Health and safety:

Plastit LR does not fall into the hazard classifications of current regulations. However, it should not be swallowed or allowed to come into contact with skin and eyes.

Suitable protective gloves and goggles should be worn. Splashes on the skin should be removed with water. In case of contact with eyes rinse immediately with plenty of water and seek medical advice. If swallowed seek medical attention immediately - do not induce vomiting.

#### Fire:

Plastit LR is non-flammable.

### Sample Test Results

Table 1:

Plastit LR Kg per 100 kg cement	W/C ratio	Air content in fresh concrete (%)	Slump (cm)	Initial concrete setting time (min)	Final concrete setting time (min)	Time (day)			
						1	3	7	28
						Compressive strength (MPa)			
0	0.47	1.7	6	225	482	3.5	16.7	23.3	33.6
0.5	0.47	1	18	553	716	5.8	24.8	30.7	39.0

# Plastit<sup>®</sup> LA

## Accelerating, Water Reducing Admixture

### Uses

As an accelerator for use in concrete and cement mortars to promote rapid strength development for early stripping of formwork, and to assist in resisting of frost attack, ideal for cold winter working conditions.

### Advantages

- Allows continuous placing of concrete at low temperatures
- Gives anti-frost protection by allowing water reducing thus accelerating cement hydration process
- Allows earlier release from precast moulds
- Allows reduction in mixing water with no loss of workability
- Increased density and compressive strength

### Standards compliance

Plastit LA complies with BS5075 part1: 1974 and ASTM C494-1971

### Description

Plastit LA supplied as a brown liquid, is based on selected stabilized sugar reduced lignosulphonates blended, which when added to cementitious mixes, accelerates hydration and enables the water content to perform more efficiently.

### Typical dosage

Optimum dosage of Plastit LA to meet specific requirements should always be determined by trial mixes using the material and conditions that will be experienced in use. The normal dosage range is 0.4 to 1.0 kg/100 kg of cementitious material, including PFA, GGBFS or microsilica.

### Properties

Appearance	Brown Liquid
Specific gravity	1.15 gr/cm <sup>3</sup> at 20°C
Chloride	Nil to BS5075
Air entrainment	Typically less than 2% additional air is entrained at normal dosages.
Alkali content	Typically less than 5.0 g. Na <sub>2</sub> O equivalent/litre of admixture. A fact sheet on this subject is available.

### Instructions for use

#### Compatibility:

Plastit LA is compatible with other CAPCO admixtures in the same concrete mix. All admixtures should be added to the concrete separately and must not be premixed together prior to addition. The performance of concrete containing more than one admixture should be assessed by trial mixes.

Plastit LA is suitable for use with all types of Portland cements, SRC cements and cement replacement materials such as PFA, GGBFS and microsilica.

The use of a combination of admixtures in the same concrete mix and or cement replacements may alter

the setting time. Trials should always be conducted to determine such setting times.

#### Dispensing:

The correct quantity of Plastit LA should be measured by means of a recommended dispenser. The admixture should then be added to the concrete with the mixing water to obtain the best results.

### Packaging

Plastit LA is available in 20 kg containers and 240 kg drums.

### Storage

Plastit LA has a minimum shelf life of 12 months provided the temperature is kept within the range of 5°C to 35°C. Should the temperature of the product fall outside this range then contact CAPCO for advice.

**Freezing point:** Approximately -3°C

### Precautions

#### Health and safety:

Plastit LA does not fall into the hazard classifications of current regulations. However, it should not be swallowed or allowed to come into contact with skin and eyes. Suitable protective gloves and goggles should be worn. Splashes on the skin should be removed with water. In case of contact with eyes rinse immediately with plenty of water and seek medical advice. If swallowed seek medical attention immediately - do not induce vomiting.

#### Fire:

Plastit LA is non-flammable.

# Plastit® PN10

## Plasticizer Admixture

### Uses

- To improve the effectiveness of the water content of a concrete mix.
- At higher dosages to provide a cost effective means of reducing concrete permeability and thereby reducing water penetration.

### Advantages

- Allows specified strength grades to be met at reduced cement content or increased workability.
- Water reduction significantly improves compressive strengths at all ages and enhances durability through the production of low permeability concrete.
- Minimizes the risk of segregation and bleeding and assists in the production of a dense, close textured surface, improving durability.
- Chloride free, safe for use in prestressed and reinforced concrete.

### Standards compliance

Plastit PN10 conforms with BS 5075 Part 1 and with ASTM C494 as Type A.

### Description

Plastit PN10 is a chloride free water reducing admixture based on selected sugar-reduced lignosulphonates. It is supplied as a brown solution which instantly disperses in water. Plastit PN10 disperses the fine particles in the concrete mix, enabling the water content of the concrete to perform more effectively and improving the consistency of the concrete. This produces higher levels of workability for the same water content, allowing benefits such as water reduction and increased strengths to be taken.

### Typical dosage

The optimum dosage of Plastit PN10 to meet specific requirements should always be determined by trials using the materials and conditions that will be experienced in use. The normal dosage range is 0.5 to 1.5 kg/100 kg of cementitious material, including PFA, GGBFS and microsilica.

### Properties

Appearance	Brown Liquid
Specific gravity	1.12 gr/cm <sup>3</sup> at 20°C
Chloride	Nil to BS5075
Air entrainment	Typically less than 2% additional air is entrained at normal dosages.
Alkali content	Typically less than 5.0 g. Na <sub>2</sub> O equivalent/litre of admixture. A fact sheet on this subject is available.

### Instructions for use

#### Compatibility:

Plastit PN10 is compatible with other CAPCO admixtures in the same concrete mix. All admixtures should be added to the concrete separately and must not be premixed together prior to addition. The performance of concrete containing more than one admixture should be assessed by trial mixes.

Plastit PN10 is suitable for use with all types of Portland cements, SRC cements and cement replacement materials such as PFA, GGBFS and microsilica.

The use of a combination of admixtures in the same concrete mix and or cement replacements may alter the setting time. Trials should always be conducted to determine such setting times.

#### Dispensing:

The correct quantity of Plastit PN10 should be measured by means of a recommended dispenser. The admixture should then be added to the concrete with the mixing water to obtain the best results.

### Packaging

Plastit PN10 is available in 20 kg containers and 240 kg drums.

### Storage

Plastit PN10 has a minimum shelf life of 12 months provided the temperature is kept within the range of 5°C to 35°C. Should the temperature of the product fall outside this range then contact CAPCO for advice.

**Freezing point:** Approximately -3°C

### Precautions

#### Health and safety:

Plastit PN10 does not fall into the hazard classifications of current regulations. However, it should not be swallowed or allowed to come into contact with skin and eyes.

Suitable protective gloves and goggles should be worn. Splashes on the skin should be removed with water. In case of contact with eyes rinse immediately with plenty of water and seek medical advice. If swallowed seek medical attention immediately - do not induce vomiting.

#### Fire:

Plastit PN10 is non-flammable.



# Plastit® PG06

## Retarding, Plasticizer Admixture

### Uses

- To improve the effectiveness of the water content of a concrete mix.
- At higher dosages to provide a cost effective means of reducing concrete permeability and thereby reducing water penetration.

### Advantages

- Allows specified strength grades to be met at reduced cement content or increased workability.
- Water reduction significantly improves compressive strengths at all ages and enhances durability through the production of low permeability concrete.
- Minimizes the risk of segregation and bleeding and assists in the production of a dense, close textured surface, improving durability.
- Chloride free, safe for use in prestressed and reinforced concrete.

### Standards compliance

Plastit PG06 conforms with BS 5075 Part 1, ASTM C494 as Type B and Type D and BSEN 934-2.

### Description

Plastit PG06 is a chloride free water reducing admixture based on specially selected and blended organic polymers. It is supplied as a brown solution which instantly disperses in water. Plastit PG06 disperses the fine particles in the concrete mix, enabling the water content of the concrete to perform more effectively. The initial hydration of the cement is also delayed, resulting in a delay in the setting time of the concrete with no adverse effect on subsequent stiffening and strength gain.

### Typical dosage

The optimum dosage of Plastit PG06 to meet specific requirements should always be determined by trials using the materials and conditions that will be experienced in use. The normal dosage range is 0.5 to 1.5 kg/100 kg of cementitious material, including PFA, GGBFS and microsilica.

### Properties

Appearance	Light Brown Liquid
Specific gravity	1.03 gr/cm <sup>3</sup> at 20°C
Chloride	Nil to BS5075
Air entrainment	Typically less than 2% additional air is entrained at normal dosages.
Alkali content	Typically less than 5.0 g. Na <sub>2</sub> O equivalent/litre of admixture. A fact sheet on this subject is available.

### Instructions for use

#### Compatibility:

Plastit PG06 is compatible with other CAPCO admixtures in the same concrete mix. All admixtures should be added to the concrete separately and must not be premixed together prior to addition. The performance of concrete containing more than one admixture should be assessed by trial mixes.

Plastit PG06 is suitable for use with all types of Portland cements, SRC cements and cement replacement materials such as PFA, GGBFS and microsilica.

The use of a combination of admixtures in the same concrete mix and or cement replacements may alter the setting time. Trials should always be conducted to determine such setting times.

#### Dispensing:

The correct quantity of Plastit PG06 should be measured by means of a recommended dispenser. The admixture should then be added to the concrete with the mixing water to obtain the best results.

### Packaging

Plastit PG06 is available in 20 kg containers and 200 kg drums.

### Storage

Plastit PG06 has a minimum shelf life of 12 months provided the temperature is kept within the range of 5°C to 35°C. Should the temperature of the product fall outside this range then contact CAPCO for advice.

**Freezing point:** Approximately -3°C

### Precautions

#### Health and safety:

Plastit PG06 does not fall into the hazard classifications of current regulations. However, it should not be swallowed or allowed to come into contact with skin and eyes.

Suitable protective gloves and goggles should be worn.

Splashes on the skin should be removed with water. In case of contact with eyes rinse immediately with plenty of water and seek medical advice. If swallowed seek medical attention immediately - do not induce vomiting.

#### Fire:

Plastit PG06 is non-flammable.

# Plastit® PG06

## Sample Test Results

Table 1:

Plastit PG06 Kg per 100 kg cement	W/C ratio	Air content in fresh concrete (%)	Slump (cm)	Time (day)		
				7	1	28
				Compressive strength (MPa)		
0	0.56	1.7	7	17.3	21.5	31.5
0.5	0.51	2	7	18.5	24.2	36

# Plastit<sup>®</sup> SPN1

## High Range Water Reducing Admixture

### Uses

- Specifically developed for use in high quality concrete for workability retention at low water content.
- Provides good pumpable concrete
- Recommended for piling and mass concrete pours with improved cohesion.

### Advantages

- High range water reducing property allows the production of high quality concrete without excessive cement contents-ensures improved durability.
- Improved cohesion and particle dispersion minimizes segregation and bleeding and improves pumpability.
- Chloride free, safe for use in precast, prestressed and reinforced concrete.

### Standards compliance

Plastit SPN1 conforms with BSEN 934-2, BS 5075 Part 3 and with ASTM C494 as Type A and Type F, depending on dosage used.

### Description

Plastit SPN1 is a chloride free, superplasticising admixture based on selected polymer modified naphthalene sulphonate dispersives. Plastit SPN1 disperses by electro kinetic action in the concrete mix, enabling the water phase of the concrete to perform more effectively.

### Typical dosage

The optimum dosage of Plastit SPN1 to meet specific requirements should always be determined by trial mixes using the materials and conditions that will be experienced in use.

For normal concrete a dosage between 0.5% to 1.5% by weight of cement may be used.

### Properties

Appearance	Brown Liquid
Specific gravity	1.18 gr/cm <sup>3</sup> at 20°C
Chloride	Nil to BS5075
Air entrainment	Typically less than 2% additional air is entrained at normal dosages.
Alkali content	Typically less than 55.0 g. Na <sub>2</sub> O equivalent/litre of admixture. A fact sheet on this subject is available.

### Instructions for use

#### Compatibility:

Plastit SPN1 is compatible with other CAPCO admixtures in the same concrete mix. All admixtures should be added to the concrete separately and must not be premixed together prior to addition. The performance of concrete containing more than one admixture should be assessed by trial mixes.

Plastit SPN1 is suitable for use with all types of Portland cements, SRC cements and cement replacement materials such as PFA, GGBFS and microsilica.

The use of a combination of admixtures in the same concrete mix and or cement replacements may alter the setting time. Trials should always be conducted to determine such setting times.

#### Dispensing:

The correct quantity of Plastit SPN1 should be measured by means of a recommended dispenser. The admixture should then be added to the concrete with the mixing water to obtain the best results.

### Packaging

Plastit SPN1 is available in 20 kg containers and 240 kg drums.

### Storage

Plastit SPN1 has a minimum shelf life of 12 months provided the temperature is kept within the range of 5°C to 35°C. Should the temperature of the product fall outside this range then contact CAPCO for advice.

**Freezing point:** Approximately -2°C

### Precautions

#### Health and safety:

Plastit SPN1 does not fall into the hazard classifications of current regulations. However, it should not be swallowed or allowed to come into contact with skin and eyes.

Suitable protective gloves and goggles should be worn. Splashes on the skin should be removed with water. In case of contact with eyes rinse immediately with plenty of water and seek medical advice. If swallowed seek medical attention immediately - do not induce vomiting.

#### Fire:

Plastit SPN1 is non-flammable.

# Plastit<sup>®</sup> SPNR

## Retarding, High Range Water Reducing Admixture

### Uses

- Increases workability without extra water, reducing placing time and costs.
- Gives increased working life to fresh concrete.
- Improves cohesion, minimizing segregation and improving surface finish.
- Aids pumping by improving cohesion and reducing workability loss.
- Allows a reduction in water:cement ratio, enhancing durability by producing low permeability concrete with reduced shrinkage cracking potential.
- Chloride free, safe for use in prestressed and reinforced concrete.
- Can be used with concrete containing microsilica and other cement replacements.

### Advantages

- Good slump retention - Suitable for ready mix & hot weather concreting
- Makes possible major reductions in water:cement ratio which allow the production of high strength concrete without excessive cement contents.
- Increased workability levels are maintained for longer than with ordinary sulphonated melamine admixtures.
- Improved cohesion and particle dispersion minimizes segregation and bleeding and improves pumpability.
- Chloride free, safe for use in prestressed and reinforced concrete.

### Standards compliance

Plastit SPNR conforms with BS 5075 Part 3 and ASTM C494 as Type G.

### Description

Plastit SPNR is a chloride free workability retention admixture based on selected polymer modified naphthalene sulphonate dispersives. It is supplied as a brown solution which instantly disperses in water.

Plastit SPNR disperses the fine particles in the concrete mix, enabling the water content of the concrete to perform more effectively. The increased workability, cohesion and retardation minimizes loss of workability.

### Typical dosage

The optimum dosage Plastit SPNR to meet specific requirements should always be determined by trials using the materials and conditions that will be experienced in use. The normal dosage range is 0.7 to 1.5 kg/100 kg of cementitious material, including PFA, GGBFS and microsilica.

### Properties

Appearance	Brown Liquid
Specific gravity	1.18 gr/cm <sup>3</sup> at 20°C
Chloride	Nil to BS5075
Air entrainment	Typically less than 2% additional air is entrained at normal dosages.

Alkali content	Typically less than 55.0 g. Na <sub>2</sub> O equivalent/litre of admixture. A fact sheet on this subject is available.
----------------	---

### Instructions for use

#### Compatibility:

Plastit SPNR is compatible with other CAPCO admixtures in the same concrete mix. All admixtures should be added to the concrete separately and must not be premixed together prior to addition. The performance of concrete containing more than one admixture should be assessed by trial mixes.

Plastit SPNR is suitable for use with all types of Portland cements, SRC cements and cement replacement materials such as PFA, GGBFS and microsilica.

The use of a combination of admixtures in the same concrete mix and or cement replacements may alter the setting time. Trials should always be conducted to determine such setting times.

#### Dispensing:

The correct quantity of Plastit SPNR should be measured by means of a recommended dispenser. The admixture should then be added to the concrete with the mixing water to obtain the best results.

### Packaging

Plastit SPNR is available in 20 kg containers and 240 kg drums.

### Storage

Plastit SPNR has a minimum shelf life of 12 months provided the temperature is kept within the range of 5°C to 35°C. Should the temperature of the product fall outside this range then contact CAPCO for advice.

**Freezing point:** Approximately -4°C

### Precautions

#### Health and safety:

Plastit SPNR does not fall into the hazard classifications of current regulations. However, it should not be swallowed or allowed to come into contact with skin and eyes.

Suitable protective gloves and goggles should be worn. Splashes on the skin should be removed with water. In case of contact with eyes rinse immediately with plenty of water and seek medical advice. If swallowed seek medical attention immediately - do not induce vomiting.

#### Fire:

Plastit SPNR is non-flammable.

# Plastit<sup>®</sup> SPNA

## Accelerating, High Range Water Reducing Admixture

### Uses

- As an accelerator for use in concrete and cement mortars to promote rapid strength development for early stripping of formwork, and to assist in resisting of frost attack, ideal for cold winter working conditions
- Specifically developed for use in high quality concrete for workability retention at low water content
- Provides good pumpable concrete

### Advantages

- Allows continuous placing of concrete at low temperatures
- High range water reducing property allows the production of high quality concrete without excessive cement contents-ensures improved durability.
- Gives anti-frost protection by allowing water reducing thus accelerating cement hydration process
- Allows earlier release from precast moulds
- Allows reduction in mixing water with no loss of workability
- Increased density and compressive strength
- Chloride free, safe for use in precast, prestressed and reinforced concrete.

### Standards compliance

Plastit SPNA complies with BS5075 part1 and ASTM C494.

### Description

Plastit SPNA supplied as a brown liquid, is selected sulphonated naphthalene polymers, which when added to cementitious mixes, accelerates hydration and enables the water content to perform more efficiently.

### Typical dosage

The optimum dosage of Plastit SPNA to meet specific requirements should always be determined by trial mixes using the materials and conditions that will be experienced in use.

For normal concrete a dosage between 0.4% to 2.0% by weight of cement may be used.

### Properties

Appearance	Brown Liquid
Specific gravity	1.18 gr/cm <sup>3</sup> at 20°C
Chloride	Nil to BS5075
Air entrainment	Typically less than 2% additional air is entrained at normal dosages.
Alkali content	Typically less than 55.0 g. Na <sub>2</sub> O equivalent/litre of admixture. A fact sheet on this subject is available.

### Instructions for use

#### Compatibility:

Plastit SPNA is compatible with other CAPCO admixtures in the same concrete mix. All admixtures should be added to the concrete separately and must not be premixed together prior to addition. The performance of concrete

containing more than one admixture should be assessed by trial mixes.

Plastit SPNA is suitable for use with all types of Portland cements, SRC cements and cement replacement materials such as PFA, GGBFS and microsilica.

The use of a combination of admixtures in the same concrete mix and or cement replacements may alter the setting time. Trials should always be conducted to determine such setting times.

#### Dispensing:

The correct quantity of Plastit SPNA should be measured by means of a recommended dispenser. The admixture should then be added to the concrete with the mixing water to obtain the best results.

### Packaging

Plastit SPNA is available in 20 kg containers and 240 kg drums.

### Storage

Plastit SPNA has a minimum shelf life of 12 months provided the temperature is kept within the range of 5°C to 35°C. Should the temperature of the product fall outside this range then contact CAPCO for advice.

**Freezing point:** Approximately -2°C

### Precautions

#### Health and safety:

Plastit SPNA does not fall into the hazard classifications of current regulations. However, it should not be swallowed or allowed to come into contact with skin and eyes. Suitable protective gloves and goggles should be worn. Splashes on the skin should be removed with water. In case of contact with eyes rinse immediately with plenty of water and seek medical advice. If swallowed seek medical attention immediately - do not induce vomiting.

#### Fire:

Plastit SPNA is non-flammable.

# Plastit<sup>®</sup> SPN215

## Superplasticising Admixture

### Uses

- Specifically developed for use in high quality concrete for workability retention at low water content.
- Provides good pumpable concrete
- Recommended for piling and mass concrete pours with improved cohesion.

### Advantages

- High range water reducing property allows the production of high quality concrete without excessive cement contents-ensures improved durability.
- Improved cohesion and particle dispersion minimizes segregation and bleeding and improves pumpability.
- Chloride free, safe for use in precast, prestressed and reinforced concrete.

### Standards compliance

Plastit SPN215 conforms with BSEN 934-2, BS 5075 Part 3 and with ASTM C494 as Type A and Type F, depending on dosage used.

### Description

Plastit SPN215 is a chloride free, superplasticising admixture based on selected polymer modified naphthalene sulphonate dispersives. Plastit SPN215 disperses by electro kinetic action in the concrete mix, enabling the water phase of the concrete to perform more effectively.

### Typical dosage

The optimum dosage of Plastit SPN215 to meet specific requirements should always be determined by trial mixes using the materials and conditions that will be experienced in use.

For normal concrete a dosage between 0.4% to 1.5% by weight of cement may be used.

### Properties

Appearance	Brown Liquid
Specific gravity	1.18 gr/cm <sup>3</sup> at 20°C
Chloride	Nil to BS5075
Air entrainment	Typically less than 2% additional air is entrained at normal dosages.
Alkali content	Typically less than 55.0 g. Na <sub>2</sub> O equivalent/litre of admixture. A fact sheet on this subject is available.

### Instructions for use

#### Compatibility:

Plastit SPN215 is compatible with other CAPCO admixtures in the same concrete mix. All admixtures should be added to the concrete separately and must not be premixed together prior to addition. The performance of concrete containing more than one admixture should be assessed by trial mixes.

Plastit SPN215 is suitable for use with all types of Portland

cements, SRC cements and cement replacement materials such as PFA, GGBFS and microsilica.

The use of a combination of admixtures in the same concrete mix and or cement replacements may alter the setting time. Trials should always be conducted to determine such setting times.

#### Dispensing:

The correct quantity of Plastit SPN215 should be measured by means of a recommended dispenser. The admixture should then be added to the concrete with the mixing water to obtain the best results.

### Packaging

Plastit SPN215 is available in 20 kg containers and 240 kg drums.

### Storage

Plastit SPN215 has a minimum shelf life of 12 months provided the temperature is kept within the range of 5°C to 35°C. Should the temperature of the product fall outside this range then contact CAPCO for advice.

**Freezing point:** Approximately -2°C

### Precautions

#### Health and safety:

Plastit SPN215 does not fall into the hazard classifications of current regulations. However, it should not be swallowed or allowed to come into contact with skin and eyes.

Suitable protective gloves and goggles should be worn.

Splashes on the skin should be removed with water. In case of contact with eyes rinse immediately with plenty of water and seek medical advice. If swallowed seek medical attention immediately - do not induce vomiting.

#### Fire:

Plastit SPN215 is non-flammable.

# Plastit<sup>®</sup> SPN265

## Retarding, Superplasticising Admixture

### Uses

- Increases workability without extra water, reducing placing time and costs.
- Gives increased working life to fresh concrete.
- Improves cohesion, minimizing segregation and improving surface finish.
- Aids pumping by improving cohesion and reducing workability loss.
- Allows a reduction in water:cement ratio, enhancing durability by producing low permeability concrete with reduced shrinkage cracking potential.
- Chloride free, safe for use in prestressed and reinforced concrete.
- Can be used with concrete containing microsilica and other cement replacements.

### Advantages

- Good slump retention - Suitable for ready mix & hot weather concreting
- Makes possible major reductions in water:cement ratio which allow the production of high strength concrete without excessive cement contents.
- Increased workability levels are maintained for longer than with ordinary sulphonated melamine admixtures.
- Improved cohesion and particle dispersion minimizes segregation and bleeding and improves pumpability.
- Chloride free, safe for use in prestressed and reinforced concrete.

### Standards compliance

Plastit SPN265 conforms with BS 5075 Part 3 and ASTM C494 as Type G.

### Description

Plastit SPN265 is a chloride free workability retention admixture based on selected polymer modified naphthalene sulphonate dispersives. It is supplied as a brown solution which instantly disperses in water.

Plastit SPN265 disperses the fine particles in the concrete mix, enabling the water content of the concrete to perform more effectively. The increased workability, cohesion and retardation minimizes loss of workability.

### Typical dosage

The optimum dosage Plastit SPN265 to meet specific requirements should always be determined by trials using the materials and conditions that will be experienced in use. The normal dosage range is 0.4 to 1.5 kg/100 kg of cementitious material, including PFA, GGBFS and microsilica.

### Properties

Appearance	Brown Liquid
Specific gravity	1.16 gr/cm <sup>3</sup> at 20°C
Chloride	Nil to BS5075
Air entrainment	Typically less than 2% additional air is entrained at normal dosages.

Alkali content	Typically less than 55.0 g. Na <sub>2</sub> O equivalent/litre of admixture. A fact sheet on this subject is available.
----------------	---

### Instructions for use

#### Compatibility:

Plastit SPN265 is compatible with other CAPCO admixtures in the same concrete mix. All admixtures should be added to the concrete separately and must not be premixed together prior to addition. The performance of concrete containing more than one admixture should be assessed by trial mixes.

Plastit SPN265 is suitable for use with all types of Portland cements, SRC cements and cement replacement materials such as PFA, GGBFS and microsilica.

The use of a combination of admixtures in the same concrete mix and or cement replacements may alter the setting time. Trials should always be conducted to determine such setting times.

#### Dispensing:

The correct quantity of Plastit SPN265 should be measured by means of a recommended dispenser. The admixture should then be added to the concrete with the mixing water to obtain the best results.

### Packaging

Plastit SPN265 is available in 20 kg containers and 240 kg drums.

### Storage

Plastit SPN265 has a minimum shelf life of 12 months provided the temperature is kept within the range of 5°C to 35°C. Should the temperature of the product fall outside this range then contact CAPCO for advice.

**Freezing point:** Approximately -4°C

### Precautions

#### Health and safety:

Plastit SPN265 does not fall into the hazard classifications of current regulations. However, it should not be swallowed or allowed to come into contact with skin and eyes.

Suitable protective gloves and goggles should be worn. Splashes on the skin should be removed with water. In case of contact with eyes rinse immediately with plenty of water and seek medical advice. If swallowed seek medical attention immediately - do not induce vomiting.

#### Fire:

Plastit SPN265 is non-flammable.

# Plastit<sup>®</sup> SPL90

## Retarding, High Range Water Reducing Admixture

### Uses

- Increases workability without extra water, reducing placing time and costs.
- Gives increased working life to fresh concrete.
- Improves cohesion, minimizing segregation and improving surface finish.
- Aids pumping by improving cohesion and reducing workability loss.
- Allows a reduction in water:cement ratio, enhancing durability by producing low permeability concrete with reduced shrinkage cracking potential.
- Chloride free, safe for use in prestressed and reinforced concrete.
- Can be used with concrete containing microsilica and other cement replacements.

### Advantages

- Good slump retention - Suitable for ready mix & hot weather concreting
- Makes possible major reductions in water:cement ratio which allow the production of high strength concrete without excessive cement contents.
- Improved cohesion and particle dispersion minimizes segregation and bleeding and improves pumpability.
- Chloride free, safe for use in prestressed and reinforced concrete.

### Standards compliance

Plastit SPL90 conforms with BS 5075 Part 3 and ASTM C494 as Type G.

### Description

Plastit SPL90 is a chloride free workability retention admixture based on selected specially selected and blended organic polymers. It is supplied as a brown solution which instantly disperses in water.

Plastit SPL90 disperses the fine particles in the concrete mix, enabling the water content of the concrete to perform more effectively. The increased workability, cohesion and retardation minimizes loss of workability.

### Typical dosage

The optimum dosage Plastit SPL90 to meet specific requirements should always be determined by trials using the materials and conditions that will be experienced in use. The normal dosage range is 0.3 to 1.2 kg/100 kg of cementitious material, including PFA, GGBFS and microsilica.

### Properties

Appearance	Brown Liquid
Specific gravity	1.16 gr/cm <sup>3</sup> at 20°C
Chloride	Nil to BS5075
Air entrainment	Typically less than 2% additional air is entrained at normal dosages.

Alkali content	Typically less than 5.0 g. Na <sub>2</sub> O equivalent/litre of admixture. A fact sheet on this subject is available.
----------------	--

### Instructions for use

#### Compatibility:

Plastit SPL90 is compatible with other CAPCO admixtures in the same concrete mix. All admixtures should be added to the concrete separately and must not be premixed together prior to addition. The performance of concrete containing more than one admixture should be assessed by trial mixes.

Plastit SPL90 is suitable for use with all types of Portland cements, SRC cements and cement replacement materials such as PFA, GGBFS and microsilica.

The use of a combination of admixtures in the same concrete mix and or cement replacements may alter the setting time. Trials should always be conducted to determine such setting times.

#### Dispensing:

The correct quantity of Plastit SPL90 should be measured by means of a recommended dispenser. The admixture should then be added to the concrete with the mixing water to obtain the best results.

### Packaging

Plastit SPL90 is available in 20 kg containers and 240 kg drums.

### Storage

Plastit SPL90 has a minimum shelf life of 12 months provided the temperature is kept within the range of 5°C to 35°C. Should the temperature of the product fall outside this range then contact CAPCO for advice.

**Freezing point:** Approximately -3°C

### Precautions

#### Health and safety:

Plastit SPL90 does not fall into the hazard classifications of current regulations. However, it should not be swallowed or allowed to come into contact with skin and eyes.

Suitable protective gloves and goggles should be worn.

Splashes on the skin should be removed with water. In case of contact with eyes rinse immediately with plenty of water and seek medical advice. If swallowed seek medical attention immediately - do not induce vomiting.

#### Fire:

Plastit SPL90 is non-flammable.



# Plastit<sup>®</sup> SPL90

## Sample Test Results

Table 1:

Plastit SPL90 Kg per 100kg cement	W/C ratio	Air content in fresh concrete (%)	Time (min)				
			0	15	30	45	60
			Slump (cm)				
0	0.48	2	7.5	-	-	-	-
0.5	0.48	1.5	22	21	20	18	17

# Plastit<sup>®</sup> SPL1

## Superplasticising Admixture

### Uses

- Specifically developed for use in high quality concrete for workability retention at low water content.
- Provides good pumpable concrete
- Recommended for piling and mass concrete pours with improved cohesion.

### Advantages

- High range water reducing property allows the production of high quality concrete without excessive cement contents-ensures improved durability.
- Improved cohesion and particle dispersion minimizes segregation and bleeding and improves pumpability.
- Chloride free, safe for use in precast, prestressed and reinforced concrete.

### Standards compliance

Plastit SPL1 conforms with BSEN 934-2, BS 5075 Part 3 and with ASTM C494 as Type A and Type F, depending on dosage used.

### Description

Plastit SPL1 is a chloride free, superplasticising admixture based on specially selected and blended synthetic polymers. It is supplied as a brown solution which instantly disperses in water. Plastit SPL1 disperses the fine particles in the concrete mix, enabling the water content of the concrete to perform more effectively. The very high levels of water reduction possible allow major increases in strength to be obtained.

### Typical dosage

The optimum dosage of Plastit SPL1 to meet specific requirements should always be determined by trial mixes using the materials and conditions that will be experienced in use.

For normal concrete a dosage between 0.3% to 0.8% by weight of cement may be used.

### Properties

Appearance	Brown Liquid
Specific gravity	1.16 gr/cm <sup>3</sup> at 20°C
Chloride	Nil to BS5075
Air entrainment	Typically less than 2% additional air is entrained at normal dosages.
Alkali content	Typically less than 5.0 g. Na <sub>2</sub> O equivalent/litre of admixture. A fact sheet on this subject is available.

### Instructions for use

#### Compatibility:

Plastit SPL1 is compatible with other CAPCO admixtures in the same concrete mix. All admixtures should be added to the concrete separately and must not be premixed together prior to addition. The performance of concrete

containing more than one admixture should be assessed by trial mixes.

Plastit SPL1 is suitable for use with all types of Portland cements, SRC cements and cement replacement materials such as PFA, GGBFS and microsilica.

The use of a combination of admixtures in the same concrete mix and or cement replacements may alter the setting time. Trials should always be conducted to determine such setting times.

#### Dispensing:

The correct quantity of Plastit SPL1 should be measured by means of a recommended dispenser. The admixture should then be added to the concrete with the mixing water to obtain the best results.

### Packaging

Plastit SPL1 is available in 20 kg containers and 240 kg drums.

### Storage

Plastit SPL1 has a minimum shelf life of 12 months provided the temperature is kept within the range of 5°C to 35°C. Should the temperature of the product fall outside this range then contact CAPCO for advice.

**Freezing point:** Approximately -2°C

### Precautions

#### Health and safety:

Plastit SPL1 does not fall into the hazard classifications of current regulations. However, it should not be swallowed or allowed to come into contact with skin and eyes.

Suitable protective gloves and goggles should be worn.

Splashes on the skin should be removed with water. In case of contact with eyes rinse immediately with plenty of water and seek medical advice. If swallowed seek medical attention immediately - do not induce vomiting.

#### Fire:

Plastit SPL1 is non-flammable.

# Plastit<sup>®</sup> SPC10

## High Performance Hyperplasticiser Admixture, Based on Polycarboxylate

### Uses

Plastit SPC10 is a high performance hyperplasticiser intended for applications where increased early and ultimate compressive strengths are required, and it has been developed for use in:

- Self compacting concrete
- Pumped concrete
- High performance concrete
- Per-cast concrete

### Advantages

- Increased early and ultimate compressive strengths
- Increased flexural strength
- Improved adhesion to reinforcing and stressing steel
- Improved resistance to carbonation
- Lower permeability
- Increased resistance to aggressive atmospheric conditions
- Reduced shrinkage and creep
- Increased durability

### Standards compliance

Plastit SPC10 conforms with BS 5075 Part 3 and with ASTM C494 as Type A and Type F, depending on dosage used.

### Description

Plastit SPC10 is differentiated from conventional superplasticisers in that it is based on a unique carboxylic ether polymer with long lateral chains. This greatly improves cement dispersion. At the start of the mixing process electrostatic dispersion occurs but the presence of the lateral chains, linked to the polymer backbone. Generate a steric hindrance which stabilizes the cement particle's capacity to separate and disperse. This mechanism considerably reduces the water demand in flowable concrete.

Plastit SPC10 combines the properties of water reduction and workability retention. It allows the production of high performance concrete and/or concrete with high workability. Plastit SPC10 is a particularly strong hyperplasticiser allowing production of consistent concrete properties around the required dosage.

### Typical dosage

The optimum dosage Plastit SPC10 to meet specific requirements should always be determined by trials using the materials and conditions that will be experienced in use. The normal dosage range is between 0.2 to 1.0 kg/100 kg of cementitious material.

### Properties

Appearance	Light Brown Liquid
Specific gravity	1.09 gr/cm <sup>3</sup> at 20°C
Chloride	Nil to BS5075
Air entrainment	Typically less than 2% additional air is entrained at normal dosages.

Alkali content	Typically less than 5 g. Na <sub>2</sub> O equivalent/litre of admixture. A fact sheet on this subject is available.
----------------	--

### Instructions for use

#### Compatibility:

Plastit SPC10 is compatible with other CAPCO admixtures in the same concrete mix. All admixtures should be added to the concrete separately and must not be premixed together prior to addition. The performance of concrete containing more than one admixture should be assessed by trial mixes.

Plastit SPC10 is suitable for use with all types of Portland cements, SRC cements and cement replacement materials such as PFA, GGBFS and microsilica.

The use of a combination of admixtures in the same concrete mix and or cement replacements may alter the setting time. Trials should always be conducted to determine such setting times.

#### Dispensing:

The correct quantity of Plastit SPC10 should be measured by means of a recommended dispenser. The admixture should then be added to the concrete with the mixing water to obtain the best results.

### Packaging

Plastit SPC10 is available in 20 kg containers and 200 kg drums.

### Storage

Plastit SPC10 has a minimum shelf life of 12 months provided the temperature is kept within the range of 5°C to 35°C. Should the temperature of the product fall outside this range then contact CAPCO for advice.

**Freezing point:** Approximately -2°C

### Precautions

#### Health and safety:

Plastit SPC10 does not fall into the hazard classifications of current regulations. However, it should not be swallowed or allowed to come into contact with skin and eyes.

Suitable protective gloves and goggles should be worn. Splashes on the skin should be removed with water. In case of contact with eyes rinse immediately with plenty of water and seek medical advice. If swallowed seek medical attention immediately - do not induce vomiting.

#### Fire:

Plastit SPC10 is non-flammable.

### Sample Test Results

Table 1:

# Plastit<sup>®</sup> SPC10

## Sample Test Results

Table 1:

Plastit SPC10 Kg per 100 kg cement	W/C ratio	Air content in fresh concrete (%)	Time (min)				
			0	15	30	45	60
			Slump (cm)				
0	0.45	2.0	3	-	-	-	-
0.25	0.45	1.1	21	17	14	9	5

# Plastit<sup>®</sup> SPCR

Retarding, High Performance Hyperplasticiser Admixture, Based on Polycarboxylate

## Uses

Plastit SPCR is a high performance hyperplasticiser intended for applications where increased early and ultimate compressive strengths are required, and it has been developed for use in:

- Self compacting concrete
- Pumped concrete
- Concrete requiring long workability retention
- High performance concrete
- Per-cast concrete

## Advantages

- Increased early and ultimate compressive strengths
- Controlled retardation extends working life and stiffening time for ease of construction
- Increased flexural strength
- Improved adhesion to reinforcing and stressing steel
- Improved resistance to carbonation
- Lower permeability
- Increased resistance to aggressive atmospheric conditions
- Reduced shrinkage and creep
- Increased durability

## Standards compliance

Plastit SPCR conforms complies with ASTM C494 Types B, D and G, depending on dosage used.

## Description

Plastit SPCR is differentiated from conventional superplasticisers in that it is based on a unique carboxylic ether polymer with long lateral chains. This greatly improves cement dispersion. At the start of the mixing process electrostatic dispersion occurs but the presence of the lateral chains, linked to the polymer backbone. Generate a steric hindrance which stabilizes the cement particle's capacity to separate and disperse. This mechanism considerably reduces the water demand in flowable concrete.

Plastit SPCR combines the properties of water reduction and workability retention. It allows the production of high performance concrete and/or concrete with high workability. Plastit SPCR is a particularly strong hyperplasticiser allowing production of consistent concrete properties around the required dosage.

## Typical dosage

The optimum dosage Plastit SPCR to meet specific requirements should always be determined by trials using the materials and conditions that will be experienced in use. The normal dosage range is between 0.3 to 1.0 kg/100 kg of cementitious material.

## Properties

Appearance	Light Brown Liquid
Specific gravity	1.08 gr/cm <sup>3</sup> at 20°C
Chloride	Nil to BS5075

Air entrainment	Typically less than 2% additional air is entrained at normal dosages.
Alkali content	Typically less than 5 g. Na <sub>2</sub> O equivalent/litre of admixture. A fact sheet on this subject is available.

## Instructions for use

### Compatibility:

Plastit SPCR is compatible with other CAPCO admixtures in the same concrete mix. All admixtures should be added to the concrete separately and must not be premixed together prior to addition. The performance of concrete containing more than one admixture should be assessed by trial mixes.

Plastit SPCR is suitable for use with all types of Portland cements, SRC cements and cement replacement materials such as PFA, GGBFS and microsilica.

The use of a combination of admixtures in the same concrete mix and or cement replacements may alter the setting time. Trials should always be conducted to determine such setting times.

### Dispensing:

The correct quantity of Plastit SPCR should be measured by means of a recommended dispenser. The admixture should then be added to the concrete with the mixing water to obtain the best results.

## Packaging

Plastit SPCR is available in 20 kg containers and 200 kg drums.

## Storage

Plastit SPCR has a minimum shelf life of 12 months provided the temperature is kept within the range of 5°C to 35°C. Should the temperature of the product fall outside this range then contact CAPCO for advice.

**Freezing point:** Approximately -2°C

## Precautions

### Health and safety:

Plastit SPCR does not fall into the hazard classifications of current regulations. However, it should not be swallowed or allowed to come into contact with skin and eyes.

Suitable protective gloves and goggles should be worn. Splashes on the skin should be removed with water. In case of contact with eyes rinse immediately with plenty of water and seek medical advice. If swallowed seek medical attention immediately - do not induce vomiting.

### Fire:

Plastit SPCR is non-flammable.

# Plastit<sup>®</sup> SPCA

Accelerating, High Performance Hyperplasticiser Admixture, Based on Polycarboxylate

## Uses

Plastit SPCA is a high performance hyperplasticiser intended for applications where increased early compressive strengths are required, and it has been developed for use in:

- Self compacting concrete
- Concreting in cold weather
- Pumped concrete
- High performance concrete
- Per-cast concrete

## Advantages

- Increased early compressive strengths
- Increased flexural strength
- Improved adhesion to reinforcing and stressing steel
- Improved resistance to carbonation
- Lower permeability
- Increased resistance to aggressive atmospheric conditions
- Reduced shrinkage and creep
- Increased durability

## Standards compliance

Plastit SPCA conforms with BS 5075 Part 3 and with ASTM C494 as Type E and Type F, depending on dosage used.

## Description

Plastit SPCA is differentiated from conventional superplasticisers in that it is based on a unique carboxylic ether polymer with long lateral chains. This greatly improves cement dispersion. At the start of the mixing process electrostatic dispersion occurs but the presence of the lateral chains, linked to the polymer backbone. Generate a steric hindrance which stabilizes the cement particle's capacity to separate and disperse. This mechanism considerably reduces the water demand in flowable concrete.

Plastit SPCA is a particularly strong hyperplasticiser allowing production of consistent concrete properties around the required dosage.

## Typical dosage

The optimum dosage Plastit SPCA to meet specific requirements should always be determined by trials using the materials and conditions that will be experienced in use. The normal dosage range is between 0.2 to 1.0 kg/100 kg of cementitious material.

## Properties

Appearance	Light Brown Liquid
Specific gravity	1.09 gr/cm <sup>3</sup> at 20°C
Chloride	Nil to BS5075
Air entrainment	Typically less than 2% additional air is entrained at normal dosages.

Alkali content	Typically less than 5 g. Na <sub>2</sub> O equivalent/litre of admixture. A fact sheet on this subject is available.
----------------	--

## Instructions for use

### Compatibility:

Plastit SPCA is compatible with other CAPCO admixtures in the same concrete mix. All admixtures should be added to the concrete separately and must not be premixed together prior to addition. The performance of concrete containing more than one admixture should be assessed by trial mixes.

Plastit SPCA is suitable for use with all types of Portland cements, SRC cements and cement replacement materials such as PFA, GGBFS and microsilica.

The use of a combination of admixtures in the same concrete mix and or cement replacements may alter the setting time. Trials should always be conducted to determine such setting times.

### Dispensing:

The correct quantity of Plastit SPCA should be measured by means of a recommended dispenser. The admixture should then be added to the concrete with the mixing water to obtain the best results.

## Packaging

Plastit SPCA is available in 20 kg containers and 200 kg drums.

## Storage

Plastit SPCA has a minimum shelf life of 12 months provided the temperature is kept within the range of 5°C to 35°C. Should the temperature of the product fall outside this range then contact CAPCO for advice.

**Freezing point:** Approximately -2°C

## Precautions

### Health and safety:

Plastit SPCA does not fall into the hazard classifications of current regulations. However, it should not be swallowed or allowed to come into contact with skin and eyes.

Suitable protective gloves and goggles should be worn. Splashes on the skin should be removed with water. In case of contact with eyes rinse immediately with plenty of water and seek medical advice. If swallowed seek medical attention immediately - do not induce vomiting.

### Fire:

Plastit SPCA is non-flammable.

# Plastit<sup>®</sup> SPC435

## High Performance Hyperplasticiser Admixture, Based on Polycarboxylate

### Uses

Plastit SPC435 is a high performance hyperplasticiser intended for applications where increased early and ultimate compressive strengths are required, and it has been developed for use in:

- Self compacting concrete
- Pumped concrete
- High performance concrete
- Per-cast concrete

### Advantages

- Increased early and ultimate compressive strengths
- Increased flexural strength
- Improved adhesion to reinforcing and stressing steel
- Improved resistance to carbonation
- Lower permeability
- Increased resistance to aggressive atmospheric conditions
- Reduced shrinkage and creep
- Increased durability

### Standards compliance

Plastit SPC435 conforms with BS 5075 Part 3 and with ASTM C494 as Type A and Type F, depending on dosage used.

### Description

Plastit SPC435 is differentiated from conventional superplasticisers in that it is based on a unique carboxylic ether polymer with long lateral chains. This greatly improves cement dispersion. At the start of the mixing process electrostatic dispersion occurs but the presence of the lateral chains, linked to the polymer backbone. Generate a steric hindrance which stabilizes the cement particle's capacity to separate and disperse. This mechanism considerably reduces the water demand in flowable concrete.

Plastit SPC435 combines the properties of water reduction and workability retention. It allows the production of high performance concrete and/or concrete with high workability. Plastit SPC435 is a particularly strong hyperplasticiser allowing production of consistent concrete properties around the required dosage.

### Typical dosage

The optimum dosage Plastit SPC435 to meet specific requirements should always be determined by trials using the materials and conditions that will be experienced in use. The normal dosage range is between 0.4 to 1.0 kg/100 kg of cementitious material.

### Properties

Appearance	Light Brown Liquid
Specific gravity	1.08 gr/cm <sup>3</sup> at 20°C
Chloride	Nil to BS5075
Air entrainment	Typically less than 2% additional air is entrained at normal dosages.

Alkali content	Typically less than 5 g. Na <sub>2</sub> O equivalent/litre of admixture. A fact sheet on this subject is available.
----------------	--

### Instructions for use

#### Compatibility:

Plastit SPC435 is compatible with other CAPCO admixtures in the same concrete mix. All admixtures should be added to the concrete separately and must not be premixed together prior to addition. The performance of concrete containing more than one admixture should be assessed by trial mixes.

Plastit SPC435 is suitable for use with all types of Portland cements, SRC cements and cement replacement materials such as PFA, GGBFS and microsilica.

The use of a combination of admixtures in the same concrete mix and or cement replacements may alter the setting time. Trials should always be conducted to determine such setting times.

#### Dispensing:

The correct quantity of Plastit SPC435 should be measured by means of a recommended dispenser. The admixture should then be added to the concrete with the mixing water to obtain the best results.

### Packaging

Plastit SPC435 is available in 20 kg containers and 200 kg drums.

### Storage

Plastit SPC435 has a minimum shelf life of 12 months provided the temperature is kept within the range of 5°C to 35°C. Should the temperature of the product fall outside this range then contact CAPCO for advice.

**Freezing point:** Approximately -2°C

### Precautions

#### Health and safety:

Plastit SPC435 does not fall into the hazard classifications of current regulations. However, it should not be swallowed or allowed to come into contact with skin and eyes.

Suitable protective gloves and goggles should be worn. Splashes on the skin should be removed with water. In case of contact with eyes rinse immediately with plenty of water and seek medical advice. If swallowed seek medical attention immediately - do not induce vomiting.

#### Fire:

Plastit SPC435 is non-flammable.

# Plastit® SPC100

## High Range Water Reducing Admixture, Based on Polycarboxylate

### Uses

Plastit SPC100 is a high performance hyperplasticiser intended for applications where increased early and ultimate compressive strengths are required, and it has been developed for use in:

- Self compacting concrete
- Pumped concrete
- High performance concrete
- Per-cast concrete

### Advantages

- Increased early and ultimate compressive strengths
- Increased flexural strength
- Improved adhesion to reinforcing and stressing steel
- Improved resistance to carbonation
- Lower permeability
- Increased resistance to aggressive atmospheric conditions
- Reduced shrinkage and creep
- Increased durability

### Standards compliance

Plastit SPC100 conforms with BS 5075 Part 3 and with ASTM C494 as Type A and Type F, depending on dosage used.

### Description

Plastit SPC100 is differentiated from conventional superplasticisers in that it is based on a unique carboxylic ether polymer with long lateral chains. This greatly improves cement dispersion. At the start of the mixing process electrostatic dispersion occurs but the presence of the lateral chains, linked to the polymer backbone. Generate a steric hindrance which stabilizes the cement particle's capacity to separate and disperse. This mechanism considerably reduces the water demand in flowable concrete.

Plastit SPC100 is a particularly strong hyperplasticiser allowing production of consistent concrete properties around the required dosage.

### Typical dosage

The optimum dosage Plastit SPC100 to meet specific requirements should always be determined by trials using the materials and conditions that will be experienced in use. The normal dosage range is between 0.4 to 1.2 kg/100 kg of cementitious material.

### Properties

Appearance	Light Brown Liquid
Specific gravity	1.09 gr/cm <sup>3</sup> at 20°C
Chloride	Nil to BS5075
Air entrainment	Typically less than 2% additional air is entrained at normal dosages.

Alkali content	Typically less than 5 g. Na <sub>2</sub> O equivalent/litre of admixture. A fact sheet on this subject is available.
----------------	--

### Instructions for use

#### Compatibility

Plastit SPC100 is compatible with other CAPCO admixtures in the same concrete mix. All admixtures should be added to the concrete separately and must not be premixed together prior to addition. The performance of concrete containing more than one admixture should be assessed by trial mixes.

Plastit SPC100 is suitable for use with all types of Portland cements, SRC cements and cement replacement materials such as PFA, GGBFS and microsilica.

The use of a combination of admixtures in the same concrete mix and or cement replacements may alter the setting time. Trials should always be conducted to determine such setting times.

#### Dispensing

The correct quantity of Plastit SPC100 should be measured by means of a recommended dispenser. The admixture should then be added to the concrete with the mixing water to obtain the best results.

### Packaging

Plastit SPC100 is available in 20 kg containers and 200 kg drums.

### Storage

Plastit SPC100 has a minimum shelf life of 12 months provided the temperature is kept within the range of 5°C to 35°C. Should the temperature of the product fall outside this range then contact CAPCO for advice.

**Freezing point:** Approximately -2°C

### Precautions

#### Health and safety:

Plastit SPC100 does not fall into the hazard classifications of current regulations. However, it should not be swallowed or allowed to come into contact with skin and eyes.

Suitable protective gloves and goggles should be worn. Splashes on the skin should be removed with water. In case of contact with eyes rinse immediately with plenty of water and seek medical advice. If swallowed seek medical attention immediately - do not induce vomiting.

#### Fire:

Plastit SPC100 is non-flammable.



# Plastit® SPC100

## Sample Test Results

Table 1:

Plastit SPC100 Kg per 100 kg cement	W/C ratio	Air content in fresh concrete (%)	Time (min)				
			0	15	30	45	60
			Slump (cm)				
0	0.5	1.8	8	-	-	-	-
0.35	0.5	1.2	21	19	18	16	15

# Plastit<sup>®</sup> SPCR100

## Retarding, High Range Water Reducing Admixture, Based on Polycarboxylate

### Uses

Plastit SPCR100 is a high performance hyperplasticiser intended for applications where increased early and ultimate compressive strengths are required, and it has been developed for use in:

- Self compacting concrete
- Pumped concrete
- Concrete requiring long workability retention
- High performance concrete
- Per-cast concrete

### Advantages

- Increased early and ultimate compressive strengths
- Controlled retardation extends working life and stiffening time for ease of construction
- Increased flexural strength
- Improved adhesion to reinforcing and stressing steel
- Improved resistance to carbonation
- Lower permeability
- Increased resistance to aggressive atmospheric conditions
- Reduced shrinkage and creep
- Increased durability

### Standards compliance

Plastit SPCR100 conforms complies with ASTM C494 Types B, D and G, depending on dosage used.

### Description

Plastit SPCR100 is differentiated from conventional superplasticisers in that it is based on a unique carboxylic ether polymer with long lateral chains. This greatly improves cement dispersion. At the start of the mixing process electrostatic dispersion occurs but the presence of the lateral chains, linked to the polymer backbone. Generate a steric hindrance which stabilizes the cement particle's capacity to separate and disperse. This mechanism considerably reduces the water demand in flowable concrete.

Plastit SPCR100 combines the properties of water reduction and workability retention. It allows the production of high performance concrete and/or concrete with high workability.

Plastit SPCR100 is a particularly strong hyperplasticiser allowing production of consistent concrete properties around the required dosage.

### Typical dosage

The optimum dosage Plastit SPCR100 to meet specific requirements should always be determined by trials using the materials and conditions that will be experienced in use. The normal dosage range is between 0,4 to 1,2 kg/100 kg of cementitious material.

### Properties

Appearance	Light Brown Liquid
Specific gravity	1,1 gr/cm <sup>3</sup> at 20°C
Chloride	Nil to BS0,05

Air entrainment	Typically less than 2% additional air is entrained at normal dosages.
Alkali content	Typically less than 0 g. Na <sub>2</sub> O equivalent/litre of admixture. A fact sheet on this subject is available.

### Instructions for use

#### Compatibility:

Plastit SPCR100 is compatible with other CAPCO admixtures in the same concrete mix. All admixtures should be added to the concrete separately and must not be premixed together prior to addition. The performance of concrete containing more than one admixture should be assessed by trial mixes.

Plastit SPCR100 is suitable for use with all types of Portland cements, SRC cements and cement replacement materials such as PFA, GGBFS and microsilica.

The use of a combination of admixtures in the same concrete mix and or cement replacements may alter the setting time. Trials should always be conducted to determine such setting times.

#### Dispensing:

The correct quantity of Plastit SPCR100 should be measured by means of a recommended dispenser. The admixture should then be added to the concrete with the mixing water to obtain the best results.

### Packaging

Plastit SPCR100 is available in 20 kg containers and 200 kg drums.

### Storage

Plastit SPCR100 has a minimum shelf life of 12 months provided the temperature is kept within the range of 0°C to 20°C. Should the temperature of the product fall outside this range then contact CAPCO for advice.

**Freezing point:** Approximately 0°C

### Precautions

#### Health and safety:

Plastit SPCR100 does not fall into the hazard classifications of current regulations. However, it should not be swallowed or allowed to come into contact with skin and eyes. Suitable protective gloves and goggles should be worn. Splashes on the skin should be removed with water. In case of contact with eyes rinse immediately with plenty of water and seek medical advice. If swallowed seek medical attention immediately - do not induce vomiting.

#### Fire:

Plastit SPCR100 is non-flammable.

# Plastit® SPCA100

## Accelerating, High Range Water Reducing Admixture, Based on Polycarboxylate

### Uses

Plastit SPCA100 is a high performance hyperplasticiser intended for applications where increased early compressive strengths are required, and it has been developed for use in:

- Self compacting concrete
- Concreting in cold weather
- Pumped concrete
- High performance concrete
- Per-cast concrete

### Advantages

- Increased early compressive strengths
- Increased flexural strength
- Improved adhesion to reinforcing and stressing steel
- Improved resistance to carbonation
- Lower permeability
- Increased resistance to aggressive atmospheric conditions
- Reduced shrinkage and creep
- Increased durability

### Standards compliance

Plastit SPCA100 conforms with BS 5075 Part 3 and with ASTM C494 as Type E and Type F, depending on dosage used.

### Description

Plastit SPCA100 is differentiated from conventional superplasticisers in that it is based on a unique carboxylic ether polymer with long lateral chains. This greatly improves cement dispersion. At the start of the mixing process electrostatic dispersion occurs but the presence of the lateral chains, linked to the polymer backbone. Generate a steric hindrance which stabilizes the cement particle's capacity to separate and disperse. This mechanism considerably reduces the water demand in flowable concrete.

Plastit SPCA100 is a particularly strong hyperplasticiser allowing production of consistent concrete properties around the required dosage.

### Typical dosage

The optimum dosage Plastit SPCA100 to meet specific requirements should always be determined by trials using the materials and conditions that will be experienced in use. The normal dosage range is between 0.4 to 1.2 kg/100 kg of cementitious material.

### Properties

Appearance	Light Brown Liquid
Specific gravity	1.09 gr/cm <sup>3</sup> at 20°C
Chloride	Nil to BS5075
Air entrainment	Typically less than 2% additional air is entrained at normal dosages.

Alkali content	Typically less than 7 g. Na <sub>2</sub> O equivalent/litre of admixture. A fact sheet on this subject is available.
----------------	--

### Instructions for use

#### Compatibility:

Plastit SPCA100 is compatible with other CAPCO admixtures in the same concrete mix. All admixtures should be added to the concrete separately and must not be premixed together prior to addition. The performance of concrete containing more than one admixture should be assessed by trial mixes.

Plastit SPCA100 is suitable for use with all types of Portland cements, SRC cements and cement replacement materials such as PFA, GGBFS and microsilica.

The use of a combination of admixtures in the same concrete mix and or cement replacements may alter the setting time. Trials should always be conducted to determine such setting times.

#### Dispensing:

The correct quantity of Plastit SPCA100 should be measured by means of a recommended dispenser. The admixture should then be added to the concrete with the mixing water to obtain the best results.

### Packaging

Plastit SPCA100 is available in 20 kg containers and 200 kg drums.

### Storage

Plastit SPCA100 has a minimum shelf life of 12 months provided the temperature is kept within the range of 5°C to 35°C. Should the temperature of the product fall outside this range then contact CAPCO for advice.

**Freezing point:** Approximately -2°C

### Precautions

#### Health and safety:

Plastit SPCA100 does not fall into the hazard classifications of current regulations. However, it should not be swallowed or allowed to come into contact with skin and eyes.

Suitable protective gloves and goggles should be worn. Splashes on the skin should be removed with water. In case of contact with eyes rinse immediately with plenty of water and seek medical advice. If swallowed seek medical attention immediately - do not induce vomiting.

#### Fire:

Plastit SPCA100 is non-flammable.

# Plastit<sup>®</sup> SPC218

## High Range Water Reducing Admixture, Based on Polycarboxylate

### Uses

Plastit SPC218 is a high performance hyperplasticiser intended for applications where increased early and ultimate compressive strengths are required, and it has been developed for use in:

- Self compacting concrete
- Pumped concrete
- High performance concrete
- Per-cast concrete

### Advantages

- Increased early and ultimate compressive strengths
- Increased flexural strength
- Improved adhesion to reinforcing and stressing steel
- Improved resistance to carbonation
- Lower permeability
- Increased resistance to aggressive atmospheric conditions
- Reduced shrinkage and creep
- Increased durability

### Standards compliance

Plastit SPC218 conforms with BS 5075 Part 3 and with ASTM C494 as Type A and Type F, depending on dosage used.

### Description

Plastit SPC218 is differentiated from conventional superplasticisers in that it is based on a unique carboxylic ether polymer with long lateral chains. This greatly improves cement dispersion. At the start of the mixing process electrostatic dispersion occurs but the presence of the lateral chains, linked to the polymer backbone. Generate a steric hindrance which stabilizes the cement particle's capacity to separate and disperse. This mechanism considerably reduces the water demand in flowable concrete.

Plastit SPC218 is a particularly strong hyperplasticiser allowing production of consistent concrete properties around the required dosage.

### Typical dosage

The optimum dosage Plastit SPC218 to meet specific requirements should always be determined by trials using the materials and conditions that will be experienced in use. The normal dosage range is between 0.5 to 1.5 kg/100 kg of cementitious material.

### Properties

Appearance	Light Brown Liquid
Specific gravity	1.05 gr/cm <sup>3</sup> at 20°C
Chloride	Nil to BS5075
Air entrainment	Typically less than 2% additional air is entrained at normal dosages.
Alkali content	Typically less than 7 g. Na <sub>2</sub> O equivalent/litre of admixture. A fact sheet on this subject is available.

### Instructions for use

#### Compatibility:

Plastit SPC218 is compatible with other CAPCO admixtures in the same concrete mix. All admixtures should be added to the concrete separately and must not be premixed together prior to addition. The performance of concrete containing more than one admixture should be assessed by trial mixes.

Plastit SPC218 is suitable for use with all types of Portland cements, SRC cements and cement replacement materials such as PFA, GGBFS and microsilica.

The use of a combination of admixtures in the same concrete mix and or cement replacements may alter the setting time. Trials should always be conducted to determine such setting times.

#### Dispensing:

The correct quantity of Plastit SPC218 should be measured by means of a recommended dispenser. The admixture should then be added to the concrete with the mixing water to obtain the best results.

### Packaging

Plastit SPC218 is available in 20 kg containers and 200 kg drums.

### Storage

Plastit SPC218 has a minimum shelf life of 12 months provided the temperature is kept within the range of 5°C to 35°C. Should the temperature of the product fall outside this range then contact CAPCO for advice.

**Freezing point:** Approximately -2°C

### Precautions

#### Health and safety:

Plastit SPC218 does not fall into the hazard classifications of current regulations. However, it should not be swallowed or allowed to come into contact with skin and eyes.

Suitable protective gloves and goggles should be worn. Splashes on the skin should be removed with water. In case of contact with eyes rinse immediately with plenty of water and seek medical advice. If swallowed seek medical attention immediately - do not induce vomiting.

#### Fire:

Plastit SPC218 is non-flammable.

# Plastit® SPCR218

## Retarding, High Range Water Reducing Admixture, Based on Polycarboxylate

### Uses

Plastit SPCR218 is a high performance hyperplasticiser intended for applications where increased early and ultimate compressive strengths are required, and it has been developed for use in:

- Self compacting concrete
- Pumped concrete
- Concrete requiring long workability retention
- High performance concrete
- Per-cast concrete

### Advantages

- Increased early and ultimate compressive strengths
- Controlled retardation extends working life and stiffening time for ease of construction
- Increased flexural strength
- Improved adhesion to reinforcing and stressing steel
- Improved resistance to carbonation
- Lower permeability
- Increased resistance to aggressive atmospheric conditions
- Reduced shrinkage and creep
- Increased durability

### Standards compliance

Plastit SPCR218 conforms complies with ASTM C494 Types B, D and G, depending on dosage used.

### Description

Plastit SPCR218 is differentiated from conventional superplasticisers in that it is based on a unique carboxylic ether polymer with long lateral chains. This greatly improves cement dispersion. At the start of the mixing process electrostatic dispersion occurs but the presence of the lateral chains, linked to the polymer backbone. Generate a steric hindrance which stabilizes the cement particle's capacity to separate and disperse. This mechanism considerably reduces the water demand in flowable concrete.

Plastit SPCR218 combines the properties of water reduction and workability retention. It allows the production of high performance concrete and/or concrete with high workability. Plastit SPCR218 is a particularly strong hyperplasticiser allowing production of consistent concrete properties around the required dosage.

### Typical dosage

The optimum dosage Plastit SPCR218 to meet specific requirements should always be determined by trials using the materials and conditions that will be experienced in use. The normal dosage range is between 0.5 to 1.0 kg/100 kg of cementitious material.

### Properties

Appearance	Light Brown Liquid
Specific gravity	1.00 gr/cm <sup>3</sup> at 20°C
Chloride	Nil to BS 6870

Air entrainment	Typically less than 2% additional air is entrained at normal dosages.
Alkali content	Typically less than 0.05 g. Na <sub>2</sub> O equivalent/litre of admixture. A fact sheet on this subject is available.

### Instructions for use

#### Compatibility:

Plastit SPCR218 is compatible with other CAPCO admixtures in the same concrete mix. All admixtures should be added to the concrete separately and must not be premixed together prior to addition. The performance of concrete containing more than one admixture should be assessed by trial mixes.

Plastit SPCR218 is suitable for use with all types of Portland cements, SRC cements and cement replacement materials such as PFA, GGBFS and microsilica.

The use of a combination of admixtures in the same concrete mix and or cement replacements may alter the setting time. Trials should always be conducted to determine such setting times.

#### Dispensing:

The correct quantity of Plastit SPCR218 should be measured by means of a recommended dispenser. The admixture should then be added to the concrete with the mixing water to obtain the best results.

### Packaging

Plastit SPCR218 is available in 20 kg containers and 200 kg drums.

### Storage

Plastit SPCR218 has a minimum shelf life of 12 months provided the temperature is kept within the range of 0°C to 30°C. Should the temperature of the product fall outside this range then contact CAPCO for advice.

**Freezing point:** Approximately 0°C

### Precautions

#### Health and safety:

Plastit SPCR218 does not fall into the hazard classifications of current regulations. However, it should not be swallowed or allowed to come into contact with skin and eyes.

Suitable protective gloves and goggles should be worn.

Splashes on the skin should be removed with water. In case of contact with eyes rinse immediately with plenty of water and seek medical advice. If swallowed seek medical attention immediately - do not induce vomiting.

#### Fire:

Plastit SPCR218 is non-flammable.

# Plastit® SPCA218

Accelerating, High Range Water Reducing Admixture, Based on Polycarboxylate

## Uses

Plastit SPCA218 is a high performance hyperplasticiser intended for applications where increased early compressive strengths are required, and it has been developed for use in:

- Self compacting concrete
- Concreting in cold weather
- Pumped concrete
- High performance concrete
- Per-cast concrete

## Advantages

- Increased early compressive strengths
- Increased flexural strength
- Improved adhesion to reinforcing and stressing steel
- Improved resistance to carbonation
- Lower permeability
- Increased resistance to aggressive atmospheric conditions
- Reduced shrinkage and creep
- Increased durability

## Standards compliance

Plastit SPCA218 conforms with BS 5075 Part 3 and with ASTM C494 as Type E and Type F, depending on dosage used.

## Description

Plastit SPCA218 is differentiated from conventional superplasticisers in that it is based on a unique carboxylic ether polymer with long lateral chains. This greatly improves cement dispersion. At the start of the mixing process electrostatic dispersion occurs but the presence of the lateral chains, linked to the polymer backbone. Generate a steric hindrance which stabilizes the cement particle's capacity to separate and disperse. This mechanism considerably reduces the water demand in flowable concrete.

Plastit SPCA218 is a particularly strong hyperplasticiser allowing production of consistent concrete properties around the required dosage.

## Typical dosage

The optimum dosage Plastit SPCA218 to meet specific requirements should always be determined by trials using the materials and conditions that will be experienced in use. The normal dosage range is between 0.5 to 1.5 kg/100 kg of cementitious material.

## Properties

Appearance	Light Brown Liquid
Specific gravity	1.05 gr/cm <sup>3</sup> at 20°C
Chloride	Nil to BS5075
Air entrainment	Typically less than 2% additional air is entrained at normal dosages.

Alkali content	Typically less than 7 g. Na <sub>2</sub> O equivalent/litre of admixture. A fact sheet on this subject is available.
----------------	--

## Instructions for use

### Compatibility:

Plastit SPCA218 is compatible with other CAPCO admixtures in the same concrete mix. All admixtures should be added to the concrete separately and must not be premixed together prior to addition. The performance of concrete containing more than one admixture should be assessed by trial mixes.

Plastit SPCA218 is suitable for use with all types of Portland cements, SRC cements and cement replacement materials such as PFA, GGBFS and microsilica.

The use of a combination of admixtures in the same concrete mix and or cement replacements may alter the setting time. Trials should always be conducted to determine such setting times.

### Dispensing:

The correct quantity of Plastit SPCA218 should be measured by means of a recommended dispenser. The admixture should then be added to the concrete with the mixing water to obtain the best results.

## Packaging

Plastit SPCA218 is available in 20 kg containers and 200 kg drums.

## Storage

Plastit SPCA218 has a minimum shelf life of 12 months provided the temperature is kept within the range of 5°C to 35°C. Should the temperature of the product fall outside this range then contact CAPCO for advice.

**Freezing point:** Approximately -2°C

## Precautions

### Health and safety:

Plastit SPCA218 does not fall into the hazard classifications of current regulations. However, it should not be swallowed or allowed to come into contact with skin and eyes.

Suitable protective gloves and goggles should be worn.

Splashes on the skin should be removed with water. In case of contact with eyes rinse immediately with plenty of water and seek medical advice. If swallowed seek medical attention immediately - do not induce vomiting.

### Fire:

Plastit SPCA218 is non-flammable.

# Plastit<sup>®</sup> R

## Retarding Admixture

### Uses

Provides retardation in initial and final setting time in all cementitious materials.

### Advantages

- Set retardation allows extra placing time for larger pours.
- Set retardation controls stiffening time of concrete and cementitious materials in hot weather.
- Long distance transportation of concrete

### Standards compliance

Plastit R conforms with ASTM C494 as Type B.

### Description

Plastit R is a water solution of active polymers that retard cement hydration and limit slump loss in concrete and cementitious materials during hot weather and when transporting over long distances.

### Typical dosage

The optimum dosage Plastit R to meet specific requirements should always be determined by trials using the materials and conditions that will be experienced in use. The normal dosage range is 0.4 to 1.2 kg/100 kg of cementitious material, including PFA, GGBFS and microsilica.

### Properties

Appearance	Colorless liquid
Specific gravity	1.03 to 1.1 gr/cm <sup>3</sup> at 20°C
Chloride	Nil to BS5075
Air entrainment	Typically less than 2% additional air is entrained at normal dosages.
Alkali content	Typically less than 30.0 g. Na <sub>2</sub> O equivalent/litre of admixture. A fact sheet on this subject is available.

### Instructions for use

#### Compatibility:

Plastit R is compatible with other CAPCO admixtures in the same concrete mix. All admixtures should be added to the concrete separately and must not be premixed together prior to addition. The performance of concrete containing more than one admixture should be assessed by trial mixes.

Plastit R is suitable for use with all types of Portland cements, SRC cements and cement replacement materials such as PFA, GGBFS and microsilica.

The use of a combination of admixtures in the same concrete mix and or cement replacements may alter the setting time. Trials should always be conducted to determine such setting times.

#### Dispensing:

The correct quantity of Plastit R should be measured by means of a recommended dispenser. The admixture should then be added to the concrete with the mixing water to obtain the best results.

#### Packaging

Plastit R is available in 24 kg containers and 240 kg drums.

#### Storage

Plastit R has a minimum shelf life of 12 months provided the temperature is kept within the range of 5°C to 35°C. Should the temperature of the product fall outside this range then contact CAPCO for advice.

**Freezing point:** Approximately -5°C

#### Precautions

##### Health and safety:

Plastit R does not fall into the hazard classifications of current regulations. However, it should not be swallowed or allowed to come into contact with skin and eyes.

Suitable protective gloves and goggles should be worn.

Splashes on the skin should be removed with water. In case of contact with eyes rinse immediately with plenty of water and seek medical advice. If swallowed seek medical attention immediately - do not induce vomiting.

##### Fire:

Plastit R is non-flammable.

# Plastit® NCL

## Chloride free accelerating admixture

### Uses

- To accelerate the stiffening and early strength gain of Portland cement concrete and mortar
- Typical applications include concrete or mortar placed in cold weather and precast concrete

### Advantages

- Particularly effective in assisting to offset the delaying effect of low temperatures on setting and strength gain
- Accelerated setting gives added protection against early age frost attack
- Also provides a degree of water reduction or increased workability
- Suitable for use in bricklaying mortar
- Chloride free, safe for use in reinforced concrete

### Standards compliance

Plastit NCL complies with BS 5075 Part 1 and with ASTM C494 as type C and ISIRI 2930.

### Description

Plastit NCL is a chloride free accelerating admixture based on a combination of formate and nitrite salts. It is supplied as a straw coloured solution that instantly disperses in water. Plastit NCL accelerates the early stages of cement hydration, producing more rapid stiffening and allowing strength gain to commence at an earlier stage. This effect is particularly noticeable at low temperatures and is most significant in the first 24 hours after mixing.

### Typical Dosage

The optimum dosage of Plastit NCL to meet specific requirements should always be determined by trials using the materials and conditions that will be experienced in use. This allows the optimization of admixture dosage and mix design and provides a complete assessment of the concrete mix. A starting point for such trials is to use a dosage within the normal typical range of 1.00 to 4.00 kg/100 kg of cement.

### Use at other dosages

Dosages outside the typical range quoted above may be used if necessary and suitable to meet particular mix requirements, provided that adequate supervision is available. Compliance with requirements must be assessed through trial mixes. Contact the CAPCO Customer Service Department for advice in these cases.

### Effects of overdosing

An overdose of double the intended amount of Plastit NCL may result in increased acceleration. In common with other accelerators this may slightly reduce the ultimate strength of the concrete.

Testing has shown no detrimental effect on embedded steel even at four times overdose.

### Properties

Appearance	Yellow coloured liquid
Specific gravity	Typically 1.14 @ 20°C
Chloride content	Nil to BS 5075
Air entrainment	Typically less than 2%. Additional air is entrained at normal dosages.
Alkali content	Typically less than 1.5 g. Na <sub>2</sub> O equivalent/litre of admixture. A fact sheet on this subject is available

### Instructions for use

#### Compatibility:

Plastit NCL is compatible with other CAPCO admixtures in the same concrete mix. The admixtures must be added to the concrete separately with the mixing water and must not be directly mixed together prior to addition. The performance of concrete containing more than one admixture should be assessed by trial mixes to ensure the desired combination of effects is obtained.

Plastit NCL is suitable for use with ordinary Portland cement.

Contact the CAPCO Customer Service Department for advice on use with sulphate resisting cements and cement replacement materials.

#### Durability:

Plastit NCL has no detrimental effect on the protection given to embedded steel by the alkalinity of cement and is safe for use as an accelerator in situations where chloride containing admixtures cannot be used.

#### Dispensing:

The correct quantity of Plastit NCL should be measured by means of a recommended dispenser. The admixture should then be added to the concrete with the mixing water to obtain the best results.

#### Curing:

As with all structural concrete, good curing practice should be maintained. Water spray, wet hessian or a Capcure O spray applied curing membrane should be used.

### Limitations

Plastit NCL is most effective at low temperatures and early ages. Where compressive strength gain is the major requirement, and stiffening rates are less important, a more cost effective performance may be obtained through the use of a CAPCO plasticiser or superplasticiser.

Normal precautions for application of concrete in cold weather should be followed where Plastit NCL is used.

### Packaging

Plastit NCL is available in 20 kg containers and 240 kg drums.



# Plastit<sup>®</sup> NCL

## Storage

Plastit NCL has a minimum shelf life of 12 months provided the temperature is kept within the range of 5 °C to 35 °C.

**Freezing point:** Below -5 °C.

## Precautions

### **Health and safety:**

Plastit NCL does not fall into the hazard classifications of current regulations. However, it should not be swallowed or allowed to come into contact with skin and eyes.

Suitable protective gloves and goggles should be worn.

Splashes on the skin should be removed with water. In case of contact with eyes rinse immediately with plenty of water and seek medical advice. If swallowed seek medical attention immediately - do not induce vomiting.

### **Fire:**

Plastit NCL is non-flammable.

## Sample Test Results

**Table 1:**

Plastit NCL Kg per 100kg cement	W/C ratio	Air content in fresh concrete (%)	Slump (cm)	Initial setting time of cement mortar (min)	Time (day)		
					1	7	28
					Compressive Strength (kg/cm <sup>2</sup> )		
0	0.48	2	7	900 (flow table =14, W/C=0.5)	128	189	262
1	0.43	1.5	6.5	530 (flow table =13, W/C=0.45)	172	248	353

# Plastit® CL

## Accelerating Admixture for Cementitious Mortar and Unreinforced Concrete (Including Chloride)

### Uses

- To accelerate the stiffening and early strength gain of Portland cement concrete and mortar
- Typical applications include Unreinforced Concrete or mortar placed in cold weather

### Advantages

- Particularly effective in assisting to offset the delaying effect of low temperatures on setting and strength gain
- Accelerated setting gives added protection against early age frost attack
- Also provides a degree of water reduction or increased workability
- Suitable for use in bricklaying mortar

### Standards compliance

Plastit CL complies with BS 5075 Part 1 and with ASTM C494 as type C and ISIRI 2930.

### Description

Plastit CL is a Included Chloride accelerating admixture based on Calcium Chloride salts. It is supplied as a green coloured solution that instantly disperses in water. Plastit CL accelerates the early stages of cement hydration, producing more rapid stiffening and allowing strength gain to commence at an earlier stage. This effect is particularly noticeable at low temperatures and is most significant in the first 24 hours after mixing.

### Typical Dosage

The optimum dosage of Plastit CL to meet specific requirements should always be determined by trials using the materials and conditions that will be experienced in use. A starting point for such trials is to use a dosage within the normal typical range of 1.00 to 5.00 kg/100 kg of cementitious materials.

### Effects of overdosing

An overdose of double the intended amount of Plastit CL may result in increased acceleration. In common with other accelerators this may slightly reduce the ultimate strength of the concrete and mortar.

Testing has shown no detrimental effect on embedded steel even at four times overdose.

### Properties

Appearance	Yellow coloured liquid
Specific gravity	Typically 1.12 @ 20°C
Air entrainment	Typically less than 2%. Additional air is entrained at normal dosages.
Alkali content	Typically less than 1.5 g. Na <sub>2</sub> O equivalent/litre of admixture. A fact sheet on this subject is available.

### Instructions for use

#### Compatibility:

[www.capco.am](http://www.capco.am)

Plastit CL is compatible with other CAPCO admixtures in the same concrete mix. The admixtures must be added to the concrete separately with the mixing water and must not be directly mixed together prior to addition. The performance of concrete containing more than one admixture should be assessed by trial mixes to ensure the desired combination of effects is obtained.

Plastit CL is suitable for use with ordinary Portland cement.

#### Durability:

Plastit CL has no detrimental effect on the protection given to embedded steel by the alkalinity of cement and is safe for use as an accelerator in situations where chloride containing admixtures cannot be used.

#### Dispensing:

The correct quantity of Plastit CL should be measured by means of a recommended dispenser. The admixture should then be added to the concrete with the mixing water to obtain the best results.

#### Curing:

As with all structural concrete, good curing practice should be maintained. Water spray, wet hessian or a Capcure O spray applied curing membrane should be used.

### Limitations

Plastit CL is most effective at low temperatures and early ages. Where compressive strength gain is the major requirement, and stiffening rates are less important, a more cost effective performance may be obtained through the use of a CAPCO plasticiser or superplasticiser.

Normal precautions for application of concrete in cold weather should be followed where Plastit CL is used.

### Packaging

Plastit CL is available in 20 kg containers and 240 kg drums.

### Storage

Plastit CL has a minimum shelf life of 12 months provided the temperature is kept within the range of 5 °C to 35 °C.

**Freezing point:** Below -5 °C.

### Precautions

#### Health and safety:

Plastit CL does not fall into the hazard classifications of current regulations. However, it should not be swallowed or allowed to come into contact with skin and eyes.

Suitable protective gloves and goggles should be worn. Splashes on the skin should be removed with water. In case of contact with eyes rinse immediately with plenty of water and seek medical advice. If swallowed seek medical attention immediately - do not induce vomiting.

#### Fire:

Plastit CL is non-flammable.

# Plastit Sprayset®

## Powder Accelerator for Shotcrete

### Uses

Plastit Sprayset is used to provide a rapid set to sprayed concrete. This improves overhead spraying, permits thicker build in one pass and provides early support strength.

### Advantages

- Rapid set - Allows faster build and permits rapid overhead spraying
- Economic - Minimizes rebound loss
- Tolerant - Can allow spraying on surfaces subject to water ingress

### Description

This product is a fine chloride free white powder which when added to a cement/aggregate dry mix and with the addition of water gives an accelerated set to the sprayed concrete.

### Typical Dosage

The optimum dosage of Plastit Sprayset to meet specific requirements should always be determined by trials using the materials and conditions that will be experienced in use. Typical rate of addition is 4 to 7 kg of Plastit Sprayset powder/100 kg of cement.

### Properties

Appearance	White powder
Specific gravity	Typically 0.75 gr/cm <sup>3</sup>
Chloride	Nil to BS5075

### Instructions for use

#### **Compatibility:**

Plastit Sprayset is compatible with other CAPCO admixtures in the same concrete mix. The admixtures must be added to the concrete separately with the mixing water and must not be directly mixed together prior to addition. The performance of concrete containing more than one admixture should be assessed by trial mixes to ensure the desired combination of effects is obtained.

#### **Dispensing:**

Plastit Sprayset powder is added direct to the blending hopper containing mixed cement & aggregate. Accelerator only begins to work once water is added at the nozzle.

### Packaging

Plastit Sprayset is available in 15 kg bags.

### Storage

Plastit Sprayset has a minimum shelf life of 12 months at 20°C if kept in a dry store in the original, unopened packs. The shelf life will be reduced at higher ambient temperatures.

### Precautions

#### **Health and safety:**

Plastit Sprayset powder is alkaline in saturated solution PH 13. Gloves and goggles must be worn. Prolonged contact with skin should be avoided and any material washed off with water immediately. Any accidental eye contamination should be washed with plenty of water and immediate medical attention should be sought. If swallowed drink plenty of water followed by diluted vinegar or lemon juice. The treatment should be completed by drinking milk or olive oil. Medical attention should be sought. For spillages, wash with water.

#### **Fire:**

Plastit Sprayset powder is non-flammable.

# Silurry<sup>®</sup> 500

## Silica Fume Slurry Admixture

### Uses

- Any construction project requiring the protection provided by highly durable, low permeability concrete
- Projects requiring high-strength/high-performance concrete
- Steel-reinforced concrete structures or wet shotcrete applications exposed to deicing or airborne salts

### Advantages

- Increased concrete service life
- Increased strength
- Increased modulus of elasticity
- Reduced permeability thereby increasing durability
- Increased resistance to sulfate attack
- Increased resistance to alkali-silica reactivity

### Standards compliance

Silurry 500 conforms with ASTM C1240, Standard Specification for Silica Fume used in Cementitious Mixtures.

### Description

Silurry 500 admixture is based on a silica fume admixture to produce extremely strong, durable concrete. These include silica fume and Distributor admixture. Silurry 500 admixture meets the requirements of ASTM C 1240, Standard Specification for Silica Fume used in Cementitious Mixtures.

### Typical dosage

Silurry 500 silica fume admixture is recommended for use in concrete and wet shotcrete applications at an addition dosage of 2-20% by mass of cement.

### Properties

Appearance	Gray Slurry
Microsilica (Min%)	50
Specific Gravity (gr/cm <sup>3</sup> )	1.4

### Instructions for use

#### Compatibility:

Silurry 500 is compatible with other Capco admixtures used in the same concrete mix. All admixtures should be added to the mix separately and must not be mixed together prior to addition. The resultant properties of mixes containing more than one admixture should be assessed by the trial mix procedure recommended on this data sheet.

#### Dispensing:

The correct quantity of Silurry 500 should be measured by means of a suitably accurate device; and then added to the concrete during the mixing process either by hand, or mechanically.

#### Curing:

As with all structural concrete and sand : cement mixes, good curing practice should be maintained, particularly in situations where an overdose has occurred. Water

spray, wet Hessian or a Capcure O spray applied curing membrane should be used.

### Limitations

The use of a suitable Super plasticizer with this product is recommended.

### Packaging

Silurry 500 is available in 20 kg pails or 200 kg Barrels.

### Storage

Silurry 500 has a minimum shelf life of 6 months at 35°C if kept in a dry store in the original, unopened packs. The shelf life will be reduced at higher ambient temperatures.

### Precautions

#### Health and safety:

Silurry 500 is alkaline and should not come into contact with skin and eyes. Avoid inhalation of dust during mixing. Gloves, goggles and dust mask should be worn. If contact with skin occurs, wash with water. Splashes to eyes should be washed immediately with plenty of clean water and medical advice sought.

#### Fire:

Silurry 500 is non-flammable.

# Silurry®500

**Table 1:**

Silurry 500 Kg per 100 kg cement	All cementitious material	Plasit SPC10 Kg per 100 kg cement*	W/C ratio	Slump (cm)	Rapid chloride permeability (RCPT) (Coulomb)	Time (day)		
						3	7	28
						Compressive strength (kg/cm <sup>2</sup> )		
0	400	0.55	0.35	12	3676	29.3	39.3	54.6
20	400	0.7	0.35	8	1185	35.3	48	63.3

\* Plasit SPC10 is a high performance hyperplasticiser admixture, based on polycarboxylate

**Table 2:**

Silurry 500 Kg per 100 kg cement	All cementitious material	W/C ratio	Air content in fresh concrete (%)	Slump (cm)	Time (day)		
					3	7	28
					Compressive strength (kg/ cm <sup>2</sup> )		
0	350	0.50	1.8	8	140	213	302
12	371	0.53	1.3	14	171	209	322

# Capcogel<sup>®</sup>

## Silicafume Gel Admixture

### Uses

- Any construction project requiring the protection provided by highly durable, low permeability concrete
- Projects requiring high-strength/high-performance concrete
- Steel-reinforced concrete structures or wet shotcrete applications exposed to deicing or airborne salts

### Advantages

- Increased concrete service life
- Increased strength
- Increased modulus of elasticity
- Reduced permeability thereby increasing durability
- Increased resistance to sulfate attack
- Increased resistance to alkali-silica reactivity

### Standards compliance

Capcogel conforms with ASTM C1240, Standard Specification for Silica Fume used in Cementitious Mixtures.

### Description

Capcogel admixture improves the rheological properties of concrete. It is based on a highly pozzolanic mineral admixture to produce extremely strong, durable concrete. These include silica fume and Super plasticizer. This product is offered in two different types. These include:

Capcogel S: based on sulphonated naphthalene superplasticizer

Capcogel D: based on polycarboxylate superplasticizer

### Typical dosage

The optimum dosage of Capcogel to meet specific requirements should always be determined by trials using the materials and conditions that will be experienced in use. The normal dosage range is:

Capcogel S: between 3 to 20% by mass of cementitious material

Capcogel D: between 4 to 20% by mass of cementitious material

### Properties

Appearance	Gray Gel
Microsilica (Min%)	40
Specific Gravity (gr/cm <sup>3</sup> )	1.3

### Instructions for use

#### Compatibility:

Capcogel is compatible with other Capco admixtures used in the same concrete mix. All admixtures should be added to the mix separately and must not be mixed together prior to addition. The resultant properties of mixes containing more than one admixture should be assessed by the trial mix procedure recommended on this data sheet.

#### Dispensing:

The correct quantity of Capcogel should be measured by means of a suitably accurate device; and then added to

the concrete during the mixing process either by hand, or mechanically.

#### Curing:

As with all structural concrete and sand : cement mixes, good curing practice should be maintained, particularly in situations where an overdose has occurred. Water spray, wet Hessian or a Capcure O spray applied curing membrane should be used.

### Packaging

Capcogel is available in 20 kg pails or 200 kg Barrels.

### Storage

Capcogel has a minimum shelf life of 6 months at 35°C if kept in a dry store in the original, unopened packs. The shelf life will be reduced at higher ambient temperatures.

### Precautions

#### Health and safety:

Capcogel is alkaline and should not come into contact with skin and eyes. Avoid inhalation of dust during mixing. Gloves, goggles and dust mask should be worn. If contact with skin occurs, wash with water. Splashes to eyes should be washed immediately with plenty of clean water and medical advice sought.

#### Fire:

Capcogel is non-flammable.

# Capcogel®

## Sample Test Results

**Table 1:**

Capcogel S Kg per 100 kg cement	All cementitious material	W/C ratio	Air content in fresh concrete (%)	Slump (cm)	Time (day)	
					7	28
					Compressive strength (MPa)	
0	375	0.42	3	3	23.28	38.92
5	365	0.39	2.6	2	32.84	43.86

**Table 2:**

Capcogel D Kg per 100 kg cement	All cementitious material	W/C ratio	Air content in fresh concrete (%)	Slump (cm)	Time (day)	
					7	28
					Compressive strength (kg/cm <sup>2</sup> )	
0	350	0.48	2	3	198	244
7	360	0.5	1.5	18	209	295

# Silicamorf®90

## Silica Fume Mineral Powder Admixture

### Uses

- Any construction project requiring the protection provided by highly durable, low permeability concrete
- Projects requiring high-strength/high-performance concrete
- Steel-reinforced concrete structures or wet shotcrete applications exposed to deicing or airborne salts

### Advantages

- Increased concrete service life
- Increased strength
- Increased modulus of elasticity
- Reduced permeability thereby increasing durability
- Increased resistance to sulfate attack
- Increased resistance to alkali-silica reactivity

### Standards compliance

Silicamorf 90 conforms with ASTM C1240, Standard Specification for Silica Fume used in Cementitious Mixtures.

### Description

Silicamorf 90 dry, Powder silica fume admixture is formulated to produce extremely strong, durable concrete. Silicamorf 90 silica fume admixture meets the requirements of ASTM C 1240, Standard Specification for Silica Fume used in Cementitious Mixtures

### Typical dosage

Silicamorf 90 silica fume admixture is recommended for use in concrete and wet shotcrete applications at an addition dosage of 2-12% by mass of cement.

### Properties

Appearance	Light Gray Powder
Specific Gravity (kg/m <sup>3</sup> )	400-600
Structure	Amorphous
SiO <sub>2</sub> (Min%)	85
Specific Surface (m <sup>2</sup> /gr)	14-20
Bulk Density (kg/m <sup>3</sup> )	200-300
Particle Size	0.2-0.3

### Instructions for use

#### Compatibility:

Silicamorf 90 is compatible with other Capco admixtures used in the same concrete mix. All admixtures should be added to the mix separately and must not be mixed together prior to addition. The resultant properties of mixes containing more than one admixture should be assessed by the trial mix procedure recommended on this data sheet.

#### Dispensing:

The correct quantity of Silicamorf 90 should be measured by means of a suitably accurate device; and then added to the concrete during the mixing process either by hand, or mechanically.

#### Dispensing and Mixing:

For concrete and wet shotcrete, Silicamorf 90 silica fume admixture is batched at the concrete production plant in a manner similar to that for cement or other cementitious materials such as fly ash. It may be batched in a central or truck mixer. Follow the procedures outlined in ASTM C 94/C 94M, Standard Specification for Ready-Mixed Concrete or refer to the Silica Fume Association Users Manual for specific batching and mixing instructions.

#### Curing:

As with all structural concrete and sand : cement mixes, good curing practice should be maintained, particularly in situations where an overdose has occurred. Water spray, wet Hessian or a Capcure O spray applied curing membrane should be used.

### Packaging

Plasit WPL is available in:

- Big Bag (400 kg - 600 kg)
- Small Bag (30 kg - 50 kg)

### Storage

Silicamorf 90 has a minimum shelf life of 12 months at 35°C if kept in a dry store in the original, unopened packs. The shelf life will be reduced at higher ambient temperatures.

### Precautions

#### Health and safety:

Silicamorf 90 is alkaline and should not come into contact with skin and eyes. Avoid inhalation of dust during mixing. Gloves, goggles and dust mask should be worn. If contact with skin occurs, wash with water. Splashes to eyes should be washed immediately with plenty of clean water and medical advice sought.

#### Fire:

Silicamorf 90 is non-flammable.



# Silurix® 520

## Silica Fume Distributor Admixture

### Uses

- Concrete including silica fume
- production of silica fume slurry

### Advantages

- silica fume dispersion in the concrete

### Description

Silurix 520 is silica fume distributor Admixture based on selected polymers. This greatly improves silica fume dispersion in the concrete.

### Typical dosage

The optimum dosage of Silurix 520 to meet specific requirements should always be determined by trials using the materials and conditions that will be experienced in use. The normal dosage range is between 1 to 4% by mass of silica fume.

### Properties

Appearance	Colorless
Specific gravity	1.03 gr/cm <sup>3</sup> at 20°C
Chloride	Nil to BS5075
pH	7.5

### Instructions for use

#### **Compatibility:**

Silurix 520 is compatible with other Capco admixtures used in the same concrete mix. All admixtures should be added to the mix separately and must not be mixed together prior to addition. The resultant properties of mixes containing more than one admixture should be assessed by the trial mix procedure recommended on this data sheet.

#### **Dispensing:**

The correct quantity of Silurix 520 should be measured by means of a suitably accurate device; and then added to the concrete during the mixing process either by hand, or mechanically.

### Packaging

Silurix 520 is available in 20 kg and 200 kg containers.

### Storage

Silurix 520 has a minimum shelf life of 12 months provided the temperature is kept within the range of 5°C to 35°C. Should the temperature of the product fall outside this range then contact CAPCO for advice.

### Precautions

#### **Health and safety:**

Silurix 520 does not fall into the hazard classifications of current regulations. However, it should not be swallowed or allowed to come into contact with skin and eyes. Suitable protective gloves and goggles should be worn. Splashes on the skin should be removed with water. In case of contact with eyes rinse immediately with plenty of water and seek medical advice. If swallowed seek medical attention immediately - do not induce vomiting.

#### **Fire:**

Silurix 520 is non-flammable.

# Plastit® WPL

## Concrete and Mortar Integral Waterproofing Admixture, Liquid

### Uses

As an integral waterproofer for:

- Structural and precast concrete
- Sand : Cement renders
- Floor screeds
- Mortars and Plasters

### Advantages

- Allows a reduction in mix water content to be made without affecting workability, so reducing permeability.
- Provides integral protection, ensuring reduced permeability throughout the concrete and mortars.
- Integral protection is maintained even if surface damage occurs.
- Lower water: cement ratio improves compressive strength at the same workability.

### Description

Plastit WPL is water based Admixture and is supplied as a white liquid emulsion. Plastit WPL is a multipurpose, concentrated liquid polymer for making modified concrete, mortars, screed and render with better performance, improved mechanical properties and lower penetration against water, chloride and some typical chemicals.

### Typical dosage

The optimum dosage of Plastit WPL to meet specific requirements should always be determined by trials using the materials and conditions that will be experienced in use. This allows the optimization of admixture dosage and mix design and provides a complete assessment of the mix. As a guide, an addition rate of 2% to 4% by weight of cement.

### Properties

Appearance	White Liquid
Chloride	Nil to BS5075

### Instructions for use

#### Compatibility:

Plastit WPL is compatible with other Capco admixtures used in the same concrete mix. All admixtures should be added to the mix separately and must not be mixed together prior to addition. The resultant properties of mixes containing more than one admixture should be assessed by the trial mix procedure recommended on this data sheet. Plastit WPL is suitable for use with all types of Portland cements and cement replacement materials such as PFA, GGBFS and microsilica.

#### Dispensing:

The correct quantity of Plastit WPL should be measured by means of a suitably accurate device; and then added to the concrete during the mixing process either by hand, or mechanically.

#### Curing:

As with all structural concrete and sand : cement mixes, good curing practice should be maintained, particularly in situations where an overdose has occurred. Water spray, wet Hessian or a Capcure O spray applied curing membrane should be used.

#### Limitations

The use of Plastit WPL will not make poor quality concrete waterproof. Good concrete practice must be followed at all times. Well graded aggregates must be used and a minimum cement content of 300kg/m<sup>3</sup> is usually recommended. Adequate waterstops must be provided between lifts of concrete and floor bays.

It is recommended that this product be used with Suitable concrete Plasticizers.

#### Packaging

Plastit WPL is available in 20 kg containers.

#### Storage

Plastit WPL has a minimum shelf life of 6 months at 35°C if kept in a dry store in the original, unopened packs. The shelf life will be reduced at higher ambient temperatures.

#### Precautions

##### Health and safety:

Plastit WPL is mildly alkaline and should not come into contact with skin and eyes. Avoid inhalation of dust during mixing. Gloves, goggles and dust mask should be worn. If contact with skin occurs, wash with water. Splashes to eyes should be washed immediately with plenty of clean water and medical advice sought.

##### Fire:

Plastit WPL is non-flammable.

# Plastit<sup>®</sup> WP

## Concrete and Mortar Integral Waterproofing Admixture, Powder

### Uses

- As an integral waterproofer for:
- Structural and precast concrete
  - Sand : Cement renders
  - Floor screeds
  - Mortars and Plasters

### Advantages

- Allows a reduction in mix water content to be made without affecting workability, so reducing permeability.
- Provides integral protection, ensuring reduced permeability throughout the concrete and mortars.
- Integral protection is maintained even if surface damage occurs, unlike applied surface films or coatings.
- Lower water: cement ratio improves compressive strength at the same workability.
- Formulated for use in the Middle East.

### Description

Plastit WP is a chloride free integral waterproofing admixture and is supplied as a white powder. It is formulated from a blend of hydrophobic materials; which together form a matrix of insoluble, water resistant material within the cement paste.

### Typical dosage

The optimum dosage of Plastit WP to meet specific requirements should always be determined by trials using the materials and conditions that will be experienced in use. This allows the optimization of admixture dosage and mix design and provides a complete assessment of the mix. As a guide, an addition rate of 1% - 1.5% by weight of cement.

### Properties

Appearance	White powder
Chloride	Nil to BS 589

### Instructions for use

#### Compatibility:

Plastit WP is compatible with other Capco admixtures used in the same concrete mix. All admixtures should be added to the mix separately and must not be mixed together prior to addition. The resultant properties of mixes containing more than one admixture should be assessed by the trial mix procedure recommended on this data sheet. Plastit WP is suitable for use with all types of Portland cements and cement replacement materials such as PFA, GGBFS and microsilica.

#### Dispensing:

The correct quantity of Plastit WP should be measured by means of a suitably accurate device; and then added to the concrete during the mixing process either by hand, or mechanically.

#### Curing:

As with all structural concrete and sand : cement mixes, good curing practice should be maintained, particularly in situations where an overdose has occurred. Water spray, wet Hessian or a Capcure O spray applied curing membrane should be used.

#### Limitations

The use of Plastit WP will not make poor quality concrete waterproof. Good concrete practice must be followed at all times. Well graded aggregates must be used and a minimum cement content of 300 kg/m<sup>3</sup> is usually recommended. Adequate waterstops must be provided between lifts of concrete and floor bays.

It is recommended that this product be used with Suitable concrete Plasticizers.

#### Packaging

Plastit WP is available in 25 kg bags.

#### Storage

Plastit WP has a minimum shelf life of 12 months at 20°C if kept in a dry store in the original, unopened packs. The shelf life will be reduced at higher ambient temperatures.

#### Precautions

##### Health and safety:

Plastit WP is mildly alkaline and should not come into contact with skin and eyes. Avoid inhalation of dust during mixing. Gloves, goggles and dust mask should be worn. If contact with skin occurs, wash with water. Splashes to eyes should be washed immediately with plenty of clean water and medical advice sought.

##### Fire:

Plastit WP is non-flammable.

# Plastit<sup>®</sup> VMA

## Viscosity Modifier Admixture

### Uses

- Concrete containing "gap-graded" aggregates
- Lean concrete mixtures
- Concrete as a pumping aid
- Concrete as a finishing aid
- Self-Consolidating Concrete (SCC)
- Self-Consolidating Grout

### Advantages

- Controls bleeding
- Reduces segregation, even with highly fluid concrete mixtures
- Enhances pumping and finishing
- Reduces sagging, helping plastic concrete maintain its shape on slopes and arches
- Facilitates production of highly fluid concrete mixtures such as SCC
- Facilitates placement of pervious concrete mixtures
- Superior and predictable in-place concrete properties
- Enhances surface appearance
- Flexibility in mixture proportioning
- Provides concrete stability during transport and placement

### Standards compliance

Plastit VMA conforms with ASTM C 494/C 494M as Type S and Type F.

### Description

Plastit VMA organic, viscosity-modifying admixture (VMA) is a ready-to-use, liquid admixture developed for producing concrete with enhanced viscosity and controlled rheological properties. Concrete with Plastit VMA admixture exhibits superior stability, thus increasing resistance to segregation and facilitating placement.

### Typical dosage

The optimum dosage Plastit VMA to meet specific requirements should always be determined by trials using the materials and conditions that will be experienced in use. The normal dosage range is between 0.4 to 1.5 kg/100 kg of cementitious material.

### Properties

Appearance	Colorless liquid
Specific gravity	1.01 ± 0.01 gr/cm <sup>3</sup> at 20°C
Chloride	Nil to BS5075

### Instructions for use

#### Compatibility:

Plastit VMA is compatible with other CAPCO admixtures in the same concrete mix. All admixtures should be added to the concrete separately and must not be premixed together prior to addition. The performance of concrete containing more than one admixture should be assessed by trial mixes.

Plastit VMA is suitable for use with all types of Portland cements, SRC cements and cement replacement materials

such as PFA, GGBFS and microsilica.

The use of a combination of admixtures in the same concrete mix and or cement replacements may alter the setting time. Trials should always be conducted to determine such setting times.

#### Dispensing:

The correct quantity of Plastit VMA should be measured by means of a recommended dispenser. The admixture should then be added to the concrete with the mixing water to obtain the best results.

### Packaging

Plastit VMA is available in 20 kg containers and 200 kg drums.

### Storage

Plastit VMA has a minimum shelf life of 12 months provided the temperature is kept within the range of 5°C to 35°C.

### Precautions

#### Health and safety:

Plastit VMA does not fall into the hazard classifications of current regulations. However, it should not be swallowed or allowed to come into contact with skin and eyes.

Suitable protective gloves and goggles should be worn. Splashes on the skin should be removed with water. In case of contact with eyes rinse immediately with plenty of water and seek medical advice. If swallowed seek medical attention immediately - do not induce vomiting.

#### Fire:

Plastit VMA is non-flammable.

# Plastit<sup>®</sup> AW450

## Anti-Washout Admixture

### Uses

- All types of underwater concreting where conventional concrete or placing techniques would result in a high percentage of material loss due to washout
- Mortar and grouting applications where mixtures are typically more fluid and have a higher potential for washout

### Advantages

- Reduction in washout of cement and fines
- Reduction in segregation, even with highly fluid, high water-to-cementitious materials ratio concrete mixtures
- Thixotropic action that provides concrete stiffening after placement
- Reduction or elimination of concrete bleeding

### Standards compliance

Plastit AW450 conforms with CRD-C661-06.

### Description

Plastit AW450 anti-washout admixture is a patented, ready-to-use, liquid cellulose-based admixture that is specially developed for underwater concrete applications. Concrete containing Plastit AW450 admixture exhibits superior resistance to washout of cement and fines, while impeding the blending of external water into the plastic concrete. Plastit AW450 is suitable for concrete with water-cement ratio is lower than 45%.

### Typical dosage

The optimum dosage Plastit AW450 to meet specific requirements should always be determined by trials using the materials and conditions that will be experienced in use. The normal dosage range is between 0.7 to 1.5 kg/100 kg of cementitious material.

### Properties

Appearance	Light Yellow liquid
Specific gravity	1.01 gr/cm <sup>3</sup> at 20°C
Chloride	Nil to BS5075
Air entrainment	Typically less than 2% additional air is entrained at normal dosages.

### Instructions for use

#### Compatibility:

Plastit AW450 is compatible with other CAPCO admixtures in the same concrete mix. All admixtures should be added to the concrete separately and must not be premixed together prior to addition. The performance of concrete containing more than one admixture should be assessed by trial mixes.

Plastit AW450 is suitable for use with all types of Portland cements, SRC cements and cement replacement materials such as PFA, GGBFS and microsilica.

The use of a combination of admixtures in the same concrete mix and or cement replacements may alter the setting time. Trials should always be conducted to determine such setting times.

[www.capco.am](http://www.capco.am)

### Dispensing:

The correct quantity of Plastit AW450 should be measured by means of a recommended dispenser. The admixture should then be added to the concrete with the mixing water to obtain the best results.

### Mixing:

For underwater concrete placements, ACI 304R, Chapter 8, "Concrete Placed Underwater" provides certain basic mixture proportions such as:

- A minimum total cementitious material content of 600 lb/yd<sup>3</sup> (356 kg/m<sup>3</sup>)
  - Use of pozzolans approximately 15% by mass of cementitious materials
  - A maximum water-to-cementitious materials ratio of 0.45
  - Fine aggregate contents of 45-55% by volume of total aggregate
  - Air contents of up to 5% are listed as desirable
  - A slump of 6-9 in. (150-230 mm) is generally necessary and occasionally a slightly higher slump range is needed
- For achieving additional slump, use Plastit AW450 admixture in conjunction with a Plastit SPC10 high-range water-reducing admixture.

This combination will produce a high-performance, flowing concrete that exhibits superior resistance to washout of cement and fines. Plastit AW450 admixture should be added after all other concreting ingredients have been batched and thoroughly mixed, either at the batch plant or at the jobsite.

### Packaging

Plastit AW450 is available in 20 kg containers and 200 kg drums.

### Storage

Plastit AW450 has a minimum shelf life of 12 months provided the temperature is kept within the range of 5°C to 35°C. Should the temperature of the product fall outside this range then contact CAPCO for advice.

### Precautions

#### Health and safety:

Plastit AW450 does not fall into the hazard classifications of current regulations. However, it should not be swallowed or allowed to come into contact with skin and eyes. Suitable protective gloves and goggles should be worn. Splashes on the skin should be removed with water. In case of contact with eyes rinse immediately with plenty of water and seek medical advice. If swallowed seek medical attention immediately - do not induce vomiting.

#### Fire:

Plastit AW450 is non-flammable.

# Plastit<sup>®</sup> AEA

## Air entraining agent

### Uses

To produce air entrained concrete for increased durability, resistant to damage by frost and de-icing salts, and to improve the cohesion and workability of concrete mixes where poorly graded aggregates must be used, and in any situation where bleeding, segregation or sand runs occur. Typical applications include:

- Concrete roadways
- Bridge decks
- Airport runways and taxiways
- Other extensive areas of concrete exposed to potential frost damage

### Advantages

- Provides concrete with resistance to freezing and thawing.
- Improves cohesion, reduces segregation and bleeding.
- Gives dense, uniform, close textured surface to concrete.
- Excellent air bubble stability.
- Consistent performance, even with changes in aggregate quality and ambient temperature.
- Effective in low workability concrete.
- Suitable for use in Middle East conditions.

### Standards compliance

Plastit AEA complies with BS 5075: Part 2 and with ASTM C260 as an air entraining agent.

### Description

Plastit AEA is a chloride-free admixture based on synthetic surfactants and is supplied as a dark brown solution. Plastit AEA acts on the interface of the cement/aggregate particles and mixing water to produce microscopic air bubbles evenly distributed throughout the concrete.

### Typical dosage

The optimum dosage Plastit AEA to meet specific requirements should always be determined by trials using the materials and conditions that will be experienced in use. The normal dosage range is between 0.2 to 0.6 kg/100 kg of cementitious materials.

### Properties

Appearance	Brown Liquid
Specific gravity	1.02 gr/cm <sup>3</sup> at 20°C
Chloride	Nil to BS5075
Air entrainment	Typically between 2% and 6% additional air is entrained at normal dosages.
Alkali content	Typically less than 5.0 g. Na <sub>2</sub> O equivalent/liter of admixture. A fact sheet on this subject is available.

### Instructions for use

#### Compatibility:

Plastit AEA is compatible with other CAPCO admixtures in the same concrete mix. All admixtures should be added

to the concrete separately and must not be premixed together prior to addition. The performance of concrete containing more than one admixture should be assessed by trial mixes.

Plastit AEA is suitable for use with all types of Portland cements, SRC cements and cement replacement materials such as PFA, GGBFS and micro silica.

The use of a combination of admixtures in the same concrete mix and or cement replacements may alter the setting time. Trials should always be conducted to determine such setting times.

#### Dispensing:

The correct quantity of Plastit AEA should be measured by means of a recommended dispenser. The admixture should then be added to the concrete with the mixing water to obtain the best results.

### Packaging

Plastit AEA is available in 20 kg containers and 200 kg drums.

### Storage

Plastit AEA has a minimum shelf life of 12 months provided the temperature is kept within the range of 5°C to 35°C. Should the temperature of the product fall outside this range then contact CAPCO for advice.

**Freezing point:** Approximately -2°C

### Precautions

#### Health and safety:

Plastit AEA does not fall into the hazard classifications of current regulations. However, it should not be swallowed or allowed to come into contact with skin and eyes. Suitable protective gloves and goggles should be worn. Splashes on the skin should be removed with water. In case of contact with eyes rinse immediately with plenty of water and seek medical advice. If swallowed seek medical attention immediately - do not induce vomiting.

#### Fire:

Plastit AEA is non-flammable.

# Construction Chemicals

Groutings

Concrete and Tile Adhesives

Surface Waterproofing

Concrete Surface Repairs

Floorings

Fiber

Construction  
Chemicals



# Capgrout® GP

## Expanding Cementitious Construction Grout

### Uses

Capgrout GP general purpose grouting is used where it is essential to eliminate shrinkage when completely filling the void. It can also be used for wide range of fixings. These include:

- Machine beds and base plates.
- Stanchion bases, struts, railings, and guardrail assemblies.
- Filling distance between concrete walls or other sections.
- Filling of shutter tie rod openings.
- Anchoring of tie bars, and bolts.
- Pile top re-profiling.

### Advantages

- Gaseous expansion system compensates for shrinkage and settlement in the plastic state.
- No metallic iron content to cause staining.
- Prepackaged material overcomes potential on-site batching variations.
- Develops high early strength without the use of chlorides.
- High ultimate strength and low permeability ensure the durability of the hardened grout.

### Standards compliance

Capgrout GP complies with ASTM C1107.

### Description

Capgrout GP cementitious grout is supplied as a ready to use dry powder. The addition of a controlled amount of clean water produces a flowing non-shrink grout for gap thicknesses up to 100 mm. Capgrout GP is a blend of Portland cement, graded fillers and chemical additives which impart controlled expansion in the plastic state whilst minimizing water demand. The low water demand ensures high early strength. The graded filler is designed to assist uniform mixing and produce a consistent grout.

### Properties

Appearance	Gray Cementitious Powder	
Dry Specific gravity (gr/cm <sup>3</sup> )	Approx. 2.0 @ 17°C	
Fresh Wet Specific gravity (gr/cm <sup>3</sup> )	Approx. 2.0 @ 20°C	
Compressive strength (Mpa) (ASTM C109/109M-2)	1 Day	20
	7 Days	40
	28 Days	62
Flexural strength (Mpa) (BS1319, Part 199A:3)	1 Day	2
	7 Days	7
	28 Days	10
Time to Expansion	Start: 10 minutes Finish: 3 hours	
Expansion (ASTM C490-82)	Between 2% to 2.5 @ 2.5 hours	
Total chloride ion content (as % of mass of cement)	< 1	
Application temperature	0 - 5°C	
Service temperature	0 - 20°C	

### Instructions for use

#### Preparation:

##### - Concrete surface

The substrate surface must be free from oil, grease or any loosely adherent material. If the concrete surface is defective or has laitance, it must be cut back to a sound base. Bolt holes and fixing pockets must be blown clean of any dirt or debris.

##### - Pre-soaking

For a minimum of 2 hours prior to grouting, the area of cleaned substrate should be flooded with fresh water. Immediately before grouting takes place, any free water should be removed. Particular care should be taken to blow out all bolt holes and pockets.

##### - Base plate

It is essential that this is clean and free from oil, grease or scale. Air pressure relief holes should be provided to allow venting of any isolated high spots.

##### - Leveling shims

If these are to be removed after the grout has hardened, they should be treated with a thin layer of grease.

##### - Formwork

The formwork should be constructed to be leakproof. This can be achieved by using foam rubber strip or mastic sealant beneath the constructed formwork and between joints. In some cases it is practical to use sacrificial semi dry sand and cement formwork. The formwork should include outlets for pre-soaking.

##### - Unrestrained surface area

This must be kept to a minimum. Generally the gap width between the perimeter formwork and the plate edge should not exceed 50 mm on the pouring side and 20 mm on the opposite side. It is advisable where practical to have no gap at the flank sides.

#### Mixing:

For best results a mechanically powered grout mixer should be used.

#### Consistency of mixed grout:

The quantity of clean water required to be added to a 20 kg bag to achieve the desired consistency is:

Trowellable: 2.8-2.0 litres

Flowable: 2.2-2.8 litres

The selected water content should be accurately measured into the mixer. The total contents of the Capgrout GP bag should be slowly added and continuous mixing should take place for 5 minutes. This will ensure that the grout has a smooth even consistency.

#### Grouting:

At 20°C place the grout within 10 minutes of mixing to gain full benefit of the expansion process. Capgrout GP can be placed in thicknesses up to 100 mm in a single pour when used as an underplate grout. For thicker sections it is necessary to fill out Capgrout GP with well graded



# Capgrout® GP

10mm, silt free aggregate to minimize exotherm. If bulking with aggregate is used the ratio shall not exceed 1:1. The properties of a bulked grout will differ from those published in this data sheet. Any bolt pockets must be grouted prior to grouting between the substrate and the base plate. Continuous grout flow is essential. Sufficient grout must be prepared before starting. The time taken to pour a batch must be regulated to the time taken to prepare the next one. Pouring should be from one side of the void to eliminate any air or pre-soaking water becoming trapped under the baseplate. It is advisable to pour the grout across the shortest distance of travel. The grout head must be maintained at all times so that a continuous grout front is achieved. Where large volumes have to be placed Capgrout GP may be pumped. A heavy duty diaphragm pump is recommended for this purpose. Screw feed and piston pumps may also be suitable.

## **Curing:**

On completion of the grouting operation, exposed areas should be thoroughly cured. This should be done by the use of Capcure® curing membrane, or continuous application of water and/or wet hessian.

## **Cleaning:**

Capgrout GP should be removed from tools and equipment with clean water immediately after use.

## **Packaging**

Capgrout GP is available in 25 kg bags.

## **Storage**

Capgrout GP has a minimum shelf life of 12 months at 20°C if kept in a dry store in the original, unopened packs. The shelf life will be reduced at higher ambient temperatures.

## **Precautions**

### **Health and safety:**

Capgrout GP is alkaline and should not come into contact with skin and eyes. Avoid inhalation of dust during mixing. Gloves, goggles and dust mask should be worn. If contact with skin occurs, wash with water. Splashes to eyes should be washed immediately with plenty of clean water and medical advice sought.

### **Fire:**

Capgrout GP is non-flammable.

# Capgrout® HP

## High Strength, Non-Shrink Cementitious Construction Grout

### Uses

Capgrout HP is an exceptionally high strength grout designed for grouting beneath bridge bearings, parapet posts and flanged lighting columns. It can also be used for wide range of fixings. These include:

- Machine beds and base plates.
- Stanchion bases, struts, railings, and guardrail assemblies.
- Filling distance between concrete walls or other sections.
- Filling of shutter tie rod openings.
- Anchoring of tie bars, and bolts.
- Pile top re-profiling.

### Advantages

- Non-shrink
- High early and ultimate compressive strengths
- Good flow, particularly at low temperatures
- Low permeability ensures durability
- Can be poured or pumped

### Standards compliance

Capgrout HP complies with ASTM C1107.

### Description

Capgrout HP is a ready to use dry powder supplied in 25kg moisture resistant bags. Capgrout HP has been formulated specifically for grouting of bridge bearings and parapet post base plates.

The addition of a controlled amount of clean water produces a free-flowing grout with high early and ultimate strengths as well as long term durability, suitable for use in section thicknesses 10mm to 100mm. Thicker sections can be achieved by incorporating clean, dry 10mm aggregate.

### Properties

Appearance	Gray Cementitious Powder	
Dry Specific gravity (gr/cm <sup>3</sup> )	Approx. 1.72 @ 20°C	
Fresh Wet Specific gravity (gr/cm <sup>3</sup> )	Approx. 2.02 @ 20°C	
Compressive strength (Mpa) (ASTM C109/109M-02)	1 Day	35
	7 Days	60
	28 Days	80
Flexural strength (Mpa) (BS6319, Part 3 : 1998)	1 Day	4
	7 Days	8.5
	28 Days	12
Time to Expansion	Start: 15 minutes Finish: 3 hours	
Total chloride ion content (as % of mass of cement)	< 1%	
Application temperature	4 - 50°C	
Service temperature	-20 - 200°C	

### Instructions for use

#### Preparation:

#### - Concrete surface

The substrate surface must be free from oil, grease or any loosely adherent material. If the concrete surface is defective or has laitance, it must be cut back to a sound base. Bolt holes or fixing pockets must be blown clean of any dirt or debris.

#### - Pre-soaking

For a minimum of 2 hours prior to grouting, the area of cleaned substrate should be flooded with fresh water. Immediately before grouting takes place, any free water should be removed. Particular care should be taken to blow out all bolt holes and pockets.

#### - Base plate

It is essential that this is clean and free from oil, grease or scale. Air pressure relief holes should be provided to allow venting of any isolated high spots.

#### - Leveling shims

If these are to be removed after the grout has hardened, they should be treated with a thin layer of grease.

#### - Formwork

The formwork should be constructed to be leakproof. This can be achieved by using foam rubber strip or mastic sealant beneath the constructed formwork and between joints. In some cases it is practical to use sacrificial semi dry sand and cement formwork. The formwork should include outlets for pre-soaking.

#### - Unrestrained surface area

This must be kept to a minimum. Generally the gap width between the perimeter formwork and the plate edge should not exceed 75 mm on the pouring side and 25 mm on the opposite side. It is advisable where practical to have no gap at the flank sides.

#### Mixing:

For best results a mechanically powered grout mixer should be used.

#### Consistency of mixed grout:

The quantity of clean water required to be added to a 25 kg bag to achieve the desired consistency is between 2.50 to 2.70 litres.

The selected water content should be accurately measured into the mixer. The total contents of the Capgrout HP bag should be slowly added and continuous mixing should take place for 5 minutes. This will ensure that the grout has a smooth even consistency.

#### Grouting:

Immediately prior to placement, the mixed grout should be briefly agitated to release any surface tension. Place the grout within 15 minutes of mixing to gain the full benefit of the expansion process. Capgrout HP can be placed in thicknesses 10mm to 100mm in a single pour. For thicker sections it will be necessary to fill out Capgrout HP with

# Capgrout<sup>®</sup> HP

well graded silt free aggregate to minimize exotherm. Any bolt pockets must be grouted prior to grouting between the substrate and the base plate. Continuous grout flow during the grouting operation is essential. Sufficient grout must be available prior to starting and the time taken to pour a batch must be regulated to the time taken to prepare the next one. The mixed grout should be poured only from one side of the void to eliminate the entrapment of air or surplus pre soaking water. This is best achieved by pouring the grout across the shortest distance of travel. The grout head must be maintained at all times so that a continuous grout front is achieved.

Where large volumes have to be placed Capgrout HP may be pumped. A heavy duty diaphragm pump is recommended for this purpose. Screw feed and piston pumps may also be suitable.

## **Curing:**

On completion of the grouting operation, exposed areas should be thoroughly cured. This should be done by the use of Capcure<sup>®</sup> curing membrane, or continuous application of water and/or wet hessian.

## **Cleaning:**

Capgrout HP should be removed from tools and equipment with clean water immediately after use.

## **Packaging**

Capgrout HP is available in 25 kg bags.

## **Storage**

Capgrout HP has a minimum shelf life of 12 months at 20°C if kept in a dry store in the original, unopened packs. The shelf life will be reduced at higher ambient temperatures.

## **Precautions**

### **Health and safety:**

Capgrout HP is alkaline and should not come into contact with skin and eyes. Avoid inhalation of dust during mixing. Gloves, goggles and dust mask should be worn. If contact with skin occurs, wash with water. Splashes to eyes should be washed immediately with plenty of clean water and medical advice sought.

### **Fire:**

Capgrout HP is non-flammable.

# Capgrout® FP

## Expanding Cementitious Construction Fiber Grout

### Uses

Capgrout FP general purpose grouting is used where it is essential to eliminate shrinkage when completely filling the void. It can also be used for wide range of fixings. These include:

- Machine beds and base plates.
- Stanchion bases, struts, railings, and guardrail assemblies.
- Filling distance between concrete walls or other sections.
- Filling of shutter tie rod openings.
- Anchoring of tie bars, and bolts.
- Pile top re-profiling.

### Advantages

- Gaseous expansion system compensates for shrinkage and settlement in the plastic state.
- No metallic iron content to cause staining.
- Prepackaged material overcomes potential on-site batching variations.
- Develops high early strength without the use of chlorides.
- High ultimate strength and low permeability ensure the durability of the hardened grout.

### Standards compliance

Capgrout FP complies with ASTM C1107.

### Description

Capgrout FP cementitious grout is supplied as a ready to use dry powder. The addition of a controlled amount of clean water produces a flowing non-shrink grout for gap thicknesses up to 100 mm. Capgrout FP is a blend of Portland cement, graded fillers, polypropylene fiber and chemical additives which impart controlled expansion in the plastic state whilst minimizing water demand. The low water demand ensures high early strength. The graded filler is designed to assist uniform mixing and produce a consistent grout.

### Properties

Appearance	Gray Cementitious Powder	
Dry Specific gravity (gr/cm <sup>3</sup> )	Approx. 1.70 @ 20°C	
Fresh Wet Specific gravity (gr/cm <sup>3</sup> )	Approx. 2.02 @ 20°C	
Compressive strength (Mpa) (ASTM C109/109M-02)	1 Day	25
	7 Days	45
	28 Days	62
Flexural strength (Mpa) (BS6319, Part 3 : 1998)	1 Day	2
	7 Days	7
	28 Days	9.5
Time to Expansion	Start: 15 minutes Finish: 3 hours	
Expansion (ASTM C827-87)	Between 2% to 4% @ 24 hours	
Total chloride ion content (as % of mass of cement)	< 1%	

Application temperature	4 - 50°C
Service temperature	-20 - 200°C

### Instructions for use

#### Preparation:

#### - Concrete surface

The substrate surface must be free from oil, grease or any loosely adherent material. If the concrete surface is defective or has laitance, it must be cut back to a sound base. Bolt holes and fixing pockets must be blown clean of any dirt or debris.

#### - Pre-soaking

For a minimum of 2 hours prior to grouting, the area of cleaned substrate should be flooded with fresh water. Immediately before grouting takes place, any free water should be removed. Particular care should be taken to blow out all bolt holes and pockets.

#### - Base plate

It is essential that this is clean and free from oil, grease or scale. Air pressure relief holes should be provided to allow venting of any isolated high spots.

#### - Leveling shims

If these are to be removed after the grout has hardened, they should be treated with a thin layer of grease.

#### - Formwork

The formwork should be constructed to be leakproof. This can be achieved by using foam rubber strip or mastic sealant beneath the constructed formwork and between joints. In some cases it is practical to use sacrificial semi dry sand and cement formwork. The formwork should include outlets for pre-soaking.

#### - Unrestrained surface area

This must be kept to a minimum. Generally the gap width between the perimeter formwork and the plate edge should not exceed 75 mm on the pouring side and 25 mm on the opposite side. It is advisable where practical to have no gap at the flank sides.

#### Mixing:

For best results a mechanically powered grout mixer should be used.

#### Consistency of mixed grout:

The quantity of clean water required to be added to a 25 kg bag to achieve the desired consistency is:

Trowellable: 2.50-2.80 litres

Flowable: 2.8-3.2 litres

The selected water content should be accurately measured into the mixer. The total contents of the Capgrout FP bag should be slowly added and continuous mixing should take place for 5 minutes. This will ensure that the grout has a smooth even consistency.

# Capgrout® FP

## **Grouting:**

At 25°C place the grout within 15 minutes of mixing to gain full benefit of the expansion process. Capgrout FP can be placed in thicknesses up to 100 mm in a single pour when used as an underplate grout. For thicker sections it is necessary to fill out Capgrout FP with well graded 10mm, silt free aggregate to minimize exotherm. If bulking with aggregate is used the ratio shall not exceed 1:1. The properties of a bulked grout will differ from those published in this data sheet. Any bolt pockets must be grouted prior to grouting between the substrate and the base plate. Continuous grout flow is essential. Sufficient grout must be prepared before starting. The time taken to pour a batch must be regulated to the time taken to prepare the next one. Pouring should be from one side of the void to eliminate any air or pre-soaking water becoming trapped under the baseplate. It is advisable to pour the grout across the shortest distance of travel. The grout head must be maintained at all times so that a continuous grout front is achieved. Where large volumes have to be placed Capgrout FP may be pumped. A heavy duty diaphragm pump is recommended for this purpose. Screw feed and piston pumps may also be suitable.

## **Curing:**

On completion of the grouting operation, exposed areas should be thoroughly cured. This should be done by the use of Capcure® curing membrane, or continuous application of water and/or wet hessian.

## **Cleaning:**

Capgrout FP should be removed from tools and equipment with clean water immediately after use.

## **Packaging**

Capgrout FP is available in 25 kg bags.

## **Storage**

Capgrout FP has a minimum shelf life of 12 months at 20°C if kept in a dry store in the original, unopened packs. The shelf life will be reduced at higher ambient temperatures.

## **Precautions**

### **Health and safety:**

Capgrout FP is alkaline and should not come into contact with skin and eyes. Avoid inhalation of dust during mixing. Gloves, goggles and dust mask should be worn. If contact with skin occurs, wash with water. Splashes to eyes should be washed immediately with plenty of clean water and medical advice sought.

### **Fire:**

Capgrout FP is non-flammable.

# Betonex<sup>®</sup>

## Plasticized Expanding Grout and Mortar Admixture

### Uses

Betonex is an admixture for cementitious grouts where a reduced water/cement ratio and positive expansion is required. Applications include bed grouting, duct grouting, non-shrink infilling and jointing.

### Advantages

- Gaseous expansion system compensates for plastic shrinkage and settlement in properly designed cementitious grout.
- Reduced water/cement ratio mixes in the grout mix ensures low permeability and long term durability in service.
- Gives high grout fluidity with low water/cement ratio, thus making placement or injection of the grout easy.
- No metallic iron content to corrode and cause staining or deterioration due to rust expansion in the grout.
- Composition allows high early strength development in grouts, without the use of chlorides.

### Standards compliance

Betonex is a suitable pre-stressing grout admixture when complying with BS 8110, Part 1:1985, section 8.9.4.6.

### Description

Betonex is supplied as a powder admixture. The material is a combination of a plasticizing agent and a gas producing expansion medium.

The plasticizing agent allows the use of a reduced water/cement ratio with consequent increased strengths and durability.

The expansive medium counteracts the natural settlement and plastic shrinkage of the grout and aids stability and cohesion.

Sufficient restrained expansion is developed to ensure a high degree of interfacial contact.

### Typical dosage

The optimum dosage of Betonex to meet specific requirements should always be determined by trials using the materials and conditions that will be experienced in use. The normal dosage range is 0.5 Kg/100 kg of cementitious material to achieve expansion up to 4%.

### Properties

Appearance	Light Brown powder
Chloride	Nil to BS5075

### Instructions for use

#### Compatibility:

Betonex is compatible with other Capco admixtures used in the same concrete mix. All admixtures should be added to the mix separately and must not be mixed together prior to addition. The resultant properties of mixes containing more than one admixture should be assessed by the trial mix procedure recommended on this data sheet. Betonex is suitable for use with all types of Portland cements and

cement replacement materials such as PFA, GGBFS and microsilica.

#### Dispensing:

The correct quantity of Betonex should be measured by means of a suitably accurate device; and then added to the mortar during the mixing process either by hand, or mechanically.

### Limitations

Betonex is not compatible with High Alumina Cement (Portland cement type V).

### Packaging

Betonex is available in 250 gr bags.

### Storage

Betonex has a minimum shelf life of 12 months at 35°C if kept in a dry store in the original, unopened packs. The shelf life will be reduced at higher ambient temperatures.

### Precautions

#### Health and safety:

Betonex is mildly alkaline and should not come into contact with skin and eyes. Avoid inhalation of dust during mixing. Gloves, goggles and dust mask should be worn. If contact with skin occurs, wash with water. Splashes to eyes should be washed immediately with plenty of clean water and medical advice sought.

#### Fire:

Betonex is non-flammable.

# Capcobond® AR

## Acrylic Emulsion Bonding Agent for Concrete Repairs

### Uses

Recommended primer for the cementitious repair system.

### Advantages

- Allows a reduction in mix water content to be made without affecting workability, so reducing permeability.
- Provides integral protection, ensuring reduced permeability throughout the concrete and mortars.
- Integral protection is maintained even if surface damage occurs, unlike applied surface films or coatings.
- Lower water: cement ratio improves compressive strength at the same workability.
- Formulated for use in the Middle East.

### Standards compliance

BS 6920 - Approved for use with potable water.

### Description

Capcobond AR is a modified acrylic emulsion, specially designed for use as a bonding aid and curing agent for concrete repair systems. It is resistant to hydrolysis and can therefore be used for external application.

### Properties

Appearance	White Emulsion
Chloride	Nil to BS5075

### Instructions for use

#### Surface preparation:

Clean the surface and remove any dust, unsound or contaminated material, plaster, oil, paint, grease, corrosion deposits or algae.

Where breaking out is not required, roughen the surface and remove any laitance by light scabbling or grit blasting. Expose fully any corroded steel in the repair area and remove all loose scale and corrosion deposits. Steel should be cleaned to bright condition paying particular attention to the back of the exposed steel bars. Grit blasting is recommended for this process.

#### Application of bonding aid:

The substrate should be thoroughly soaked with clean water with any excess removed prior to commencement of the works.

Scrub Capcobond AR into the substrate, avoid ponding and remove any excess. The repair mortar or topping should be applied whilst the primer is still tacky.

#### Mix design:

A sample mix design for a patching repair mortar or render.  
 50 kg Ordinary Portland cement  
 150 kg sand (0-5 mm)  
 5 litres Capcobond AR  
 Water: Sufficient to give required consistency

#### Curing:

Cure the repair mortar or topping using Capcobond AR

to prevent rapid loss of water. In severe drying conditions additional curing methods may be necessary. Protect uncured mortar from frost and rain.

#### Cleaning:

Capcobond AR should be removed from tools, equipment and mixers with clean water immediately after use. Cured material can only be removed mechanically.

#### Limitations:

Capcobond AR mortars, toppings and renders should not be used when the temperature is below 5°C and falling. Neither should they be exposed to moving water during application. Exposure to heavy rainfall prior to the final set may result in surface scour.

### Packaging

Capcobond AR is available in 4 & 20 litre containers.

### Storage

Capcobond AR has a minimum shelf life of 6 months at 35°C if kept in a dry store in the original, unopened packs. The shelf life will be reduced at higher ambient temperatures.

### Precautions

#### Health and safety:

Capcobond AR is alkaline and should not come into contact with skin and eyes. Avoid inhalation of dust during mixing. Gloves, goggles and dust mask should be worn. If contact with skin occurs, wash with water. Splashes to eyes should be washed immediately with plenty of clean water and medical advice sought.

#### Fire:

Capcobond AR is non-flammable.

# Capcobond® PVA

## Multi-purpose PVA adhesive, sealer and cement admixture

### Uses

As a multipurpose adhesive: plaster bonding agent: primer and integral bonding agent for concrete and granolithic floor repairs: repair of natural and reconstructed stone: bonding agent for tiles: bonding granolithic toppings to sub-concrete, dust proofing floor screeds and friable concrete flooring: primer for overcoating bitumen with oil based paints.

### Advantages

- Single component liquid, gauged as required
- Bonds most common construction materials
- Improves the durability of mortars and renders
- Excellent as a dust proofer and sealer
- Easily applied by brush roller or spray
- Contains no chloride admixtures
- Versatile and economical

### Standards compliance

BS 6920 - Approved for use with potable water

### Description

Capcobond PVA multipurpose adhesive is supplied as a ready to use white liquid based on a polymerized resin emulsion.

### Properties

Appearance	White viscous emulsion
Specific gravity	Typically 1.0 gr/cm <sup>3</sup> @ 20°C
Chloride	Nil to BS5075

### Instructions for use

#### Surface preparation:

Saw cut the extremities of any repair locations to a depth of at least 10 mm to avoid feather-edging and to provide a square edge.

Clean the surface and remove any dust, unsound or contaminated material, plaster, oil, paint, grease, corrosion deposits or algae. Where breaking out is not required, roughen the surface and remove any laitance by light scabbling, grit blasting or other suitable mechanical means.

Oil and grease deposits should be removed by steam cleaning, detergent scrubbing or the use of a proprietary degreaser. The effectiveness of decontamination should then be assessed by a pull-off-test.

#### Surface sealing:

Porous surfaces should be sealed with a solution of 1 part Capcobond PVA to 15 parts clean water.

Where surface porosity is extremely high it may be necessary to increase the concentration to 1 part Nitobond PVA to 10 parts water.

Breeze, foam, slag and other lightweight building blocks are exceptionally absorbent and will require pre-soaking prior to sealing.

### Application:

Please note: Capcobond PVA should not be used as a bonding agent in continuously wet areas. In such conditions Capcobond AR is recommended.

Capcobond PVA may be applied by brush or roller as indicated in the following specific applications:

#### 1. As a General Adhesive

Bonds asbestos, bricks, carpet, china, concrete, cork, earthenware, glass, laminated plastic, leather, linoleum, plasterboards, polystyrene, renders, roofing felt, stone, textiles, tiles and wood.

After surface preparation, apply a thin film of Capcobond PVA over both faces and allow becoming tacky (20 to 30 minutes depending upon temperature).

Bring the surfaces firmly together, position as required, wipe of any excess and allow setting for 24 hours.

Do not clamp tightly as the Capcobond PVA may be squeezed out.

NB. Capcobond PVA will not bond polythene, PVC or rubber.

#### 2. As a Plaster Bonding Agent

Reduces hacking and keying and will provide an adhesive or mechanical key to receive plaster or render coats of gypsum, lightweight gypsum, or anhydrous plasters, plastering onto tiles.

For gypsum, lightweight gypsum and anhydrous plasters seal as required and prime with a solution of 1 part Capcobond PVA to one part water and allow becoming tacky. Then plaster straight onto the tacky Capcobond PVA as per the normal method.

For heavier renderings and cementitious toppings seal and prime as above and then prepare a key coat by mixing 1 part Portland cement, 1 part clean washed sharp sand, gauged to a stiff consistency with 1 part Capcobond PVA to 3 parts clean water.

Apply this to the tacky priming coat to an average thickness of 6 mm and stipple with a stiff brush, or otherwise roughen the surface to provide a good mechanical key. Allow to harden and dry thoroughly. Test for adhesion prior to applying render.

For plastering onto glazed tiles, to ensure a satisfactory bond a mechanical key should be provided by light peck hammering prior to sealing, priming and plastering as above.

#### 3. For Repairs to Concrete

Prepare and seal the surface as required, apply a priming coat of 1 part Capcobond PVA to 1 part water and allow to become tacky.

Using the same sand or fine aggregate as in the concrete to be repaired, prepare a stiff cement/sand mix in the proportions 1:2 (or leaner) gauged with 1 part Capcobond PVA to 3 parts clean water.

Compact firmly and level out with minimum troweling.

#### 4. Repairs to Natural or Reconstructed Stone

Prepare and seal the surface as required and apply the priming coat as above.



# Capcobond® PVA

Prepare a stiff mix comprising of Portland cement with original aggregate in as lean a mix as possible 1:6 (or leaner) consistent with the strength requirements gauged with 1 part Capcobond PVA to 3 parts clean water. Compact firmly and level with the minimum of troweling.

## 5. For Repairs to Concrete and Granolithic Floors

Prepare and seal the surface as required. Apply the priming coat of 1 part Capcobond PVA to 1 part water, brush well into all crevices and allow becoming tacky. The priming coat must never be allowed to dry, if it does re prime and proceed only when tacky.

Prepare a mix of 1 part of Portland cement to 2.5 parts of clean washed sharp sand, gauged to a stiff consistency with 1 part Capcobond PVA to 3 parts clean water. Then proceed as per the particular application as detailed below: Repairing Cracks and Holes in Cementitious Floors: Place the mix onto the tacky prime coat, compact firmly and level out to a smooth finish with minimum troweling. Deep holes and cracks should be filled with conventional concrete onto the tacky priming coat to within 6mm of the surface and "topped" off to above specification whilst the ordinary concrete fill is still green.

Resurfacing of worn concrete and granolithic floors: Place the mix onto the tacky sealing coat and trowel in to the surface using existing exposed aggregate as level thus replacing mortar lost by wear. Treat deep indentations or holes as per above.

Leveling of worn stair treads: Place the mix onto the tacky priming coat, compact firmly and level out to a smooth finish with the minimum of troweling. To impact a non-slip finish to the stair tread, a piece of hessian should be placed onto the newly filled area soon after troweling and lightly tamped to leave an impression of the hessian.

## 6. As a Bonding Agent for Tiles

Wood, block, cork, lino and acoustical tiles: Use Capcobond PVA as a general adhesive. If the surface is uneven, the adhesive should be filled as described below under "Polystyrene Tiles." Ceramic, concrete, quarry, clay and terrazzo tiles: Seal with a solution of 1 part Capcobond PVA to 5 parts water. Brush well into the surface and allow drying.

Before bedding tiles in sand and cement give the floor and the base of the tiles a further coat of 3 parts Capcobond PVA to 1 part water. Whilst this is still wet or tacky apply the sand and cement bedding to the base and bed the tiles.

Polystyrene tiles, plaster board and acoustic board: Prepare and seal the surface as required, then using a suitable filler such as plaster, cement, fine sand or sawdust, make a paste with a solution of 1 part Capcobond PVA to 1 part water. Apply this mixture as an adhesive coat to the tiles and surface to be bonded.

## 7. For bonding granolithic toppings to sub concrete

Prepare the surface and apply a priming coat of 1 part Capcobond PVA to 1 part water, brush well into all crevices and allow becoming tacky. The priming coat must never be allowed to dry, if it does then the surface must be reprimed. Prepare a key coat consisting of 1 part Portland cement to

1 part clean sharp sand gauged to a stiff consistency with a solution of 1 part Capcobond PVA to 3 parts water.

Spread over the area whilst the priming coat is still tacky to an average depth of 6 mm then stipple with a stiff brush to form a mechanical key i.e: as rough a surface as possible. Allow to harden thoroughly and check for adhesion prior to laying the granolithic topping.

## 8. As a primer for overcoating bitumen with oil based paints

Coat the bitumen with a solution of 1 part Capcobond PVA to 1 part water as an anti-bleed priming coat suitable for most oil-based paints.

### Curing:

Capcobond PVA mortars, toppings and renders are cement based. In common with all cementitious materials, they must be cured immediately after finishing in accordance with good concrete practice. The use of Capcure curing membranes is recommended. In harsh drying conditions, supplementary curing with damp hessian or polythene sheeting is strongly recommended.

### Cleaning:

Capcobond PVA should be removed from tools, equipment and mixers with clean water immediately after use. Spillages should be absorbed with clean sand or sawdust and disposed of in accordance with local Health and Safety regulations.

## Limitations

- Capcobond PVA mortars, toppings and renders should not be applied when the temperature is below 5°C & falling
- Neither should they be exposed to moving water during application.
- Exposure to heavy rainfall prior to the final set may result in surface scour

## Packaging

Capcobond PVA is available in 15 kg pails.

## Storage

Capcobond PVA has a minimum shelf life of 6 months at 35°C if kept in a dry store in the original, unopened packs. The shelf life will be reduced at higher ambient temperatures.

## Precautions

### Health and safety:

Cementitious mortars and slurries modified with Capcobond PVA contain cement powders which, when mixed or become damp, release alkalis which can be harmful to the skin. During use, avoid inhalation of dust and contact with skin and eyes.

Wear suitable protective clothing, gloves, eye protection and respiratory protective equipment.

Capcobond PVA should not come in contact with the skin and eyes, or be swallowed. Ensure adequate ventilation and avoid inhalation of vapours. The use of barrier creams

# Capcobond<sup>®</sup> PVA

provides additional skin protection. In case of contact with skin, rinse with plenty of clean water, then cleanse with soap and water. If swallowed, seek medical attention immediately - do not induce vomiting.

**Fire:**

Capcobond PVA is non-flammable.

# Capcobond® MO40

## A Primer for Masonry Surfaces, Bonding Additive and Waterproofing Agent for Cement Based Mixtures

### Uses

**Primer:** Apply to concrete, brick, block and fibre cement and gypsum building boards to adhere screeds, renders, cement toppings and ceramic tile adhesives. Do not use in immersed applications.

**Bonding Agent:** Improves the bond, flexural and tensile strength of mortar, renders, screeds to concrete, brick, block and render. Can be feather edged and stops surface cracking.

**Waterproofing Agent:** Waterproof renders, screeds. Improves bond, flexural and tensile strength when bonding to concrete, brick, block and render. Can be feather edged and stops surface cracking.

**Cement Based Mixtures Additive:** Improves bond strength of cement based mixtures to smooth surfaces.

### Advantages

- Allows a reduction in mix water content to be made without affecting workability, so reducing permeability.
- Provides integral protection, ensuring reduced permeability throughout the concrete and mortars.
- Integral protection is maintained even if surface damage occurs, unlike applied surface films or coatings.

### Standards compliance

BS 6920 - Approved for use with potable water.

### Description

A multipurpose acrylic primer/bonding/waterproofing agent for concrete, screeds, renders and cement based products.

### Features

#### Primer:

Capcobond MO40	Water	Cement	Sand	Coverage
1 L	2 L			22 m <sup>2</sup>

#### Bonding Agent:

Capcobond MO40	Water	Cement	Sand	Coverage
1 L	4 L	10	30	5 m <sup>2</sup> 5 mm thick

#### Waterproofing Agent:

Capcobond MO40	Water	Cement	Sand	Coverage
1 L	2 L	5	10	2 m <sup>2</sup> 5 mm thick

#### Cement Based Mixtures Additive:

Capcobond MO40	Water	Cement	Sand	Coverage
1 L	4 L	10% by weight of cementitious material is added		

### Properties

Appearance	White Emulsion
Chloride	Nil to BS5075

### Instructions for use

#### Surface preparation:

Surface to be treated must be structurally sound and free from dirt, dust, grease, efflorescence, laitance, coatings and other contaminants.

#### Application:

##### - Primer

Mix with water as directed. Apply with a hard broom or brush. After 30 minutes apply screed/topping/adhesive.

##### - Bonding Agent

Mix the Capcobond MO40 with water prior to mixing with cement and sand as directed. Adjust mix to suit user's preference.

##### - Waterproofing Agent

Mix the Capcobond MO40 with water prior to mixing with cement and sand as directed. Adjust mix to suit user's preference.

##### - Cement Based Mixtures Additive

Mix the Capcobond MO40 with water prior to mixing with cement based mixtures - as directed. Adjust mix to suit user's preference.

#### Cleaning:

Capcobond MO40 should be removed from tools, equipment and mixers with clean water immediately after use. Cured material can only be removed mechanically.

#### Limitations:

Capcobond MO40 mortars, toppings and renders should not be used when the temperature is below 5°C and falling. Neither should they be exposed to moving water during application. Exposure to heavy rainfall prior to the final set may result in surface scour.

### Packaging

Capcobond MO40 is available in 4 & 20 litre containers.

### Storage

Capcobond MO40 has a minimum shelf life of 6 months

# Capcobond® MO40

at 35°C if kept in a dry store in the original, unopened packs. The shelf life will be reduced at higher ambient temperatures.

## Precautions

### **Health and safety:**

Capcobond MO40 is alkaline and should not come into contact with skin and eyes. Avoid inhalation of dust during mixing. Gloves, goggles and dust mask should be worn. If contact with skin occurs, wash with water. Splashes to eyes should be washed immediately with plenty of clean water and medical advice sought.

### **Fire:**

Capcobond MO40 is non-flammable.

# Capcobond®121

## A Primer for Masonry Surfaces and Bonding Additive to Cement Based Mixtures

### Uses

**Primer:** Apply to concrete, brick, block and fiber cement and gypsum building boards to adhere screeds, renders, cement toppings and ceramic tile adhesives. Do not use in immersed applications.

**Cement Based Mixtures Additive:** Improves bond strength of cement based mixtures to smooth surfaces.

### Advantages

- Single component liquid, gauged as required
- Bonds most common construction materials
- Improves the durability of mortars and renders
- Excellent as a dust proofer and sealer
- Easily applied by brush roller or spray
- Contains no chloride admixtures
- Versatile and economical

### Standards compliance

BS 6920 - Approved for use with potable water.

### Description

A multipurpose polyvinyl acetate (PVA) primer/adhesive modifier additive for concrete, screeds, renders and cement based products.

### Features

#### Primer:

Capcobond 121	Water	Coverage
1 L	5 L	20 m <sup>2</sup>

#### Cement Based Mixtures Additive:

Capcobond 121	Water	Mixing
1 L	3 L	Resulting solution as mixing water added to the cement based mixtures

### Properties

Appearance	White viscous emulsion
Specific gravity	Typically 1.2 gr/cm <sup>3</sup> @ 20°C
Chloride	Nil to BS5075

### Instructions for use

#### Surface preparation:

Surface to be treated must be structurally sound and free from dirt, dust, grease, efflorescence, laitance, coatings and other contaminants.

#### Application:

##### - Primer

Mix with water as directed. Apply with a hard broom or brush. After 30 minutes apply screed/topping/adhesive.

##### - Cement Based Mixtures Additive

Mix the Capcobond 121 with water prior to mixing with cement based mixtures - as directed. Adjust mix to suit user's preference.

#### Cleaning:

Capcobond 121 should be removed from tools, equipment and mixers with clean water immediately after use. Cured material can only be removed mechanically.

#### Limitations:

Capcobond 121 mortars, toppings and renders should not be used when the temperature is below 5°C and falling.

This product should not be used in environments in contact with moisture. Capcobond MO40 used in wet environments.

### Packaging

Capcobond 121 is available in 5 & 12 kg pails.

### Storage

Capcobond 121 has a minimum shelf life of 6 months at 35°C if kept in a dry store in the original, unopened packs. The shelf life will be reduced at higher ambient temperatures.

### Precautions

#### Health and safety:

Capcobond 121 is alkaline and should not come into contact with skin and eyes. Avoid inhalation of dust during mixing. Gloves, goggles and dust mask should be worn. If contact with skin occurs, wash with water. Splashes to eyes should be washed immediately with plenty of clean water and medical advice sought.

#### Fire:

Capcobond 121 is non-flammable.

# Tilex<sup>®</sup> V2

## Polymer-Modified, One Component, High Performance, Waterproof Tile Adhesive

### Uses

Tilex V2 is a high quality adhesive for the permanent fixing of ceramic wall and floor tiles including porcelain and fully vitrified tiles, ceramic mosaics, quarry tiles, dark natural stone, terrazzo and brick slips. Typical uses include:

- Wet areas - kitchens and bathrooms
- Swimming pools
- Fixing marble tiles (up to 40 kg/m<sup>2</sup> on vertical)
- Fixing heavy elements e.g. brick slips, concrete tiles
- Bridges, underpasses and high rise buildings
- External claddings

### Advantages

- Formulated to suit Middle East conditions
- Enhanced bond and tensile strengths
- Good open time & slip resistance
- Safe and easy to use
- Water resistant - suitable for submerged conditions
- Early return to service

### Standards compliance

Tilex V2 conforms to EN 12004 class C2S2.

### Description

Tilex V2 is supplied as a single component pack, which requires only the on-site addition of clean water to produce a consistently high performance adhesive, suitable for the following substrates:

- Concrete
- Ceramic, Tile & Stone
- Cement Plaster
- Brick Masonry
- Concrete Masonry
- Cement Terrazzo
- Cement mortar beds
- Ceramic backer board

### Properties

Appearance	White & Grey Powder
Specific gravity	Typically 1.45 gr/cm <sup>3</sup> @ 20°C
Flexibility	Good
Open time (25°C)	Approx. 20 min
Tensile adhesive strength	≥ 1.5 N/mm <sup>2</sup>

### Instructions for use

#### Surface preparation:

All surfaces must be sound and thoroughly clean before Tilex V2 is applied. All traces of grease, oil and loose particles of mortar, old wallpaper, paint etc. must be physically removed.

#### Surfaces:

Tilex V2 can be applied directly on concrete, cement screeds, and cement or lime mortar. Special attention must be given to new construction prior to commencing tiling. Tiles should not be placed on concrete or blockwork until all shrinkage movement has taken place.

[www.capco.am](http://www.capco.am)

#### Mixing:

A low speed drill fitted with a suitable mixing paddle and mixing vessel of minimum 30 litre capacity are recommended.

Measure out 5litres of clean water into the mixing vessel.

Add the powder component to the mix and continue mixing for 2 to 3 minutes until a uniform, lump-free consistency is achieved.

#### Application:

Once mixed, Tilex V2 is typically spread on the substrate to a uniform thickness of 2 – 6 mm. This is then combed horizontally.

Place tiles firmly into adhesive bed ensuring good contact with a twisting motion. Only apply to areas which can be tiled in the adhesive's open wet time (up to 1 m<sup>2</sup> at a time).

#### Joints:

It is recommended that when fixing ceramic tiles, a minimum Spacing of 2 mm be left around each tile.

#### Finishing:

Remove excess adhesive with a damp cloth before material has set.

#### Cleaning:

Tilex V2 should be removed from tools, equipment and mixers with clean water immediately after use.

Cured material can only be removed mechanically.

#### Grouting:

Grout installation should be after a minimum of 24 hours curing time at 25°C.

### Limitations

- Tilex V2 should not be used when the temperature is below 5°C and falling.

- The product should not be exposed to moving water during application.

### Packaging

Tilex V2 is available in 20 kg bags.

### Storage

Tilex V2 has a minimum shelf life of 12 months at 35°C if kept in a dry store in the original, unopened packs. The shelf life will be reduced at higher ambient temperatures.

### Precautions

#### Health and safety:

Tilex V2 is alkaline and should not come into contact with skin and eyes. Avoid inhalation of dust during mixing. Gloves, goggles and dust mask should be worn. If contact with skin occurs, wash with water. Splashes to eyes should be washed immediately with plenty of clean water and medical advice sought.

#### Fire:

Tilex V2 is non-flammable.

# Tilex® V100

## Tile Adhesive for Use in Porous surfaces

### Uses

Tilex V100 is a high quality adhesive for the permanent fixing of ceramics and tiles in floors or walls. It can also be used for fixing of insulating and acoustic boards based on expanded polystyrene etc.

Typical uses include:

- Dry areas - rooms, corridors & halls
- Wet areas - kitchens, WC and bathrooms

### Advantages

- Can be used in wall and floor
- Suitable for use in Middle East conditions
- Good open wet time
- Good slip resistance
- High adhesive bond strength
- Water resistant
- Can be used in totally submerged conditions

### Standards compliance

Tilex V100 conforms with EN 12004 class C2TES1.

### Description

Tilex V100 cementitious based powder is available in grey or white colour.

### Properties

Appearance	White & Grey Powder
Specific gravity	Typically 1.5 gr/cm <sup>3</sup> @ 20°C
Open time (25°C)	Approx. 20 min
Tensile adhesive strength	≥ 1.0 N/mm <sup>2</sup>

### Instructions for use

#### Surface preparation:

All surfaces must be sound and thoroughly clean before Tilex V100 is applied. All traces of grease, oil and loose particles of mortar, old wallpaper, paint etc. must be physically removed.

#### Surfaces:

Tilex V100 can be applied directly on concrete, cement screeds, and cement or lime mortar. Special attention must be given to new construction prior to commencing tiling. Tiles should not be placed on concrete or blockwork until all shrinkage movement has taken place.

#### Mixing:

A slow speed drill fitted with a suitable mixing paddle and mixing vessel of minimum 30 litre capacity are recommended.

Measure out 5 litres of clean water into the mixing vessel. Add the powder component to the mix and continue mixing for 2 to 3 minutes until a uniform, lump-free consistency is achieved.

#### Application:

Once mixed, Tilex V100 is typically spread on the substrate

to a uniform thickness of 2 – 6 mm. This is then combed horizontally.

Place tiles firmly into adhesive bed ensuring good contact with a twisting motion. Only apply to areas which can be tiled in the adhesive's open wet time (up to 1 m<sup>2</sup> at a time).

#### Joints:

It is recommended that when fixing ceramic tiles, a minimum Spacing of 2 mm be left around each tile.

#### Finishing:

Remove excess adhesive with a damp cloth before material has set.

#### Cleaning:

Tilex V100 should be removed from tools, equipment and mixers with clean water immediately after use.

Cured material can only be removed mechanically.

#### Grouting:

Grout installation should be after a minimum of 24 hours curing time at 25°C.

### Limitations

- Tilex V100 should not be used when the temperature is below 5°C and falling.
- The product should not be exposed to moving water during application.

### Packaging

Tilex V100 is available in 20 kg bags.

### Storage

Tilex V100 has a minimum shelf life of 12 months at 35°C if kept in a dry store in the original, unopened packs. The shelf life will be reduced at higher ambient temperatures.

### Precautions

#### Health and safety:

Tilex V100 is alkaline and should not come into contact with skin and eyes. Avoid inhalation of dust during mixing. Gloves, goggles and dust mask should be worn. If contact with skin occurs, wash with water. Splashes to eyes should be washed immediately with plenty of clean water and medical advice sought.

#### Fire:

Tilex V100 is non-flammable.

# Tilex<sup>®</sup> H100

## Ceramic & Tile Adhesive for Use in Floor & Wall

### Uses

Tilex H100 is a high quality adhesive for the permanent fixing of ceramics and tiles in floors or walls.

Typical uses include:

- Dry areas - rooms, corridors & halls
- Wet areas - kitchens, WC and bathrooms when modified with Capcobond MO40

#### **Fixing ceramics on floors:**

Tilex H100 is Suitable for fixing ceramics or tiles on floors, of residential and administrative areas it is mixed by 25% of its weight with water and applied with notched trowel.

#### **Fixing tiles on floors and walls:**

According to international standards and requirements, Tile adhesives must have some specific characteristics against environmental and cyclic stresses. For improving the performance of Tilex H100 it can be combined with liquid emulsion polymers like Capcobond MO40 (for internal or external floors and walls in wet area) or Capcobond 121 (for internal floors and walls in dry area), this combination is suitable for bonding of all type of ceramics, tiles and mosaics to internal or external floors and walls.

The recommended substrates are Gypsum boards, under floor heating, old tiles, cement boards, cementitious mortar, screeds and water immersion services like swimming pools.

### Advantages

- Can be used in floors
- Good open wet time

#### **When modified with Capcobond 121 or Capcobond MO40:**

- Can be used in walls
- Good slip resistance
- High adhesive bond strength

#### **When modified with Capcobond MO40:**

- Water resistant
- Can be used in totally submerged conditions

### Standards compliance

Tilex H100 conforms with EN 12004, Class C, Type 1.

### Description

Tilex H100 cementitious based powder is available in grey or white colour.

### Properties

Appearance	White & Grey Powder
Specific gravity	Typically 1.5 gr/cm <sup>3</sup> @ 20°C
Open time (25°C)	Approx. 20 min
Tensile adhesive strength	≥ 0.7 N/mm <sup>2</sup>

### Instructions for use

#### **Surface preparation:**

All surfaces must be sound and thoroughly clean before Tilex H100 is applied. All traces of grease, oil and loose particles of mortar, old wallpaper, paint etc. must be physically removed.

#### **Surfaces:**

Tilex H100 can be applied directly on concrete, cement screeds, and cement or lime mortar. Special attention must be given to new construction prior to commencing tiling. Tiles should not be placed on concrete or blockwork until all shrinkage movement has taken place.

#### **Mixing:**

A slow speed drill fitted with a suitable mixing paddle and mixing vessel of minimum 30 litre capacity are recommended.

Measure out 5 litres of clean water into the mixing vessel. Add the powder component to the mix and continue mixing for 2 to 3 minutes until a uniform, lump-free consistency is achieved.

For modified adhesive, firstly dilute Capcobond MO40 or Capcobond 212 with water to the ratio of 1(part):1 to 3(parts) then mix mechanically or in case of small amounts with gloved hands with Tilex H100 until a uniform and homogenous mixture is achieved.

Each 20kg bag of Tilex H100 is mixed with approximately 5 of diluted Capcobond MO40 or Capcobond 212.

#### **Application:**

Once mixed, Tilex H100 is typically spread on the substrate to a uniform thickness of 2 – 6 mm. This is then combed horizontally.

Place tiles firmly into adhesive bed ensuring good contact with a twisting motion. Only apply to areas which can be tiled in the adhesive's open wet time (up to 1 m<sup>2</sup> at a time).

#### **Joints:**

It is recommended that when fixing ceramic tiles, a minimum Spacing of 2 mm be left around each tile.

#### **Finishing:**

Remove excess adhesive with a damp cloth before material has set.

#### **Cleaning:**

Tilex H100 should be removed from tools, equipment and mixers with clean water immediately after use. Cured material can only be removed mechanically.

#### **Grouting:**

Grout installation should be after a minimum of 24 hours curing time at 25°C.



# Tilex<sup>®</sup> H100

## Limitations

- Tilex H100 should not be used when the temperature is below 5°C and falling.
- The product should not be exposed to moving water during application.

## Packaging

Tilex H100 is available in 20 kg bags.

## Storage

Tilex H100 has a minimum shelf life of 12 months at 35°C if kept in a dry store in the original, unopened packs. The shelf life will be reduced at higher ambient temperatures.

## Precautions

### **Health and safety:**

Tilex H100 is alkaline and should not come into contact with skin and eyes. Avoid inhalation of dust during mixing. Gloves, goggles and dust mask should be worn. If contact with skin occurs, wash with water. Splashes to eyes should be washed immediately with plenty of clean water and medical advice sought.

### **Fire:**

Tilex H100 is non-flammable.

# Tilex<sup>®</sup> P10

## High Performance Premixed White Paste Tile Adhesive

### Uses

- Tiling on various types of cementitious based substrates
- Wet areas - kitchens and bathrooms
- For fixing ceramic, tile and stone tiles on stone and old tiles, cement and gypsum board and concrete substrates.
- Suitable for fixing both wall and floor tiles at interior and exterior environments
- Able to fix tiles on cementitious based waterproofing Materials

### Advantages

- Premixed in factory
- Strong adhesion to substrate
- Suitable for both interior & exterior use
- Sustainable to seasonal cycles
- Ample open time for application
- Non-slip properties
- Thixotropic characteristics
- Extremely low shrinkage
- Complying European Standard: EN 12004 Class D1

### Standards compliance

Tilex P10 complies with EN12004 Class D1.

### Description

Tilex P10 is a proprietary polymer based ready-to-use tile adhesive material specially designed for tile fixing purpose.

### Properties

Appearance	White Paste
Specific Gravity	1.35 gr/cm <sup>3</sup>
Damp resistance	Good
Flexibility	Good
Open time (25°C)	Approx. 20 min
Tensile adhesive strength	≥ 1 N/mm <sup>2</sup>

### Instructions for use

#### Surface preparation:

The substrate must be sound, even, well-aligned, clean and free of loose particles, grease and any other unwanted contaminants. The substrate should be allowed to cure for at least 4 – 6 weeks to ensure majority magnitude of shrinkage movement has taken place before tile fixing. Special care such as pre-priming with Capcobond MO40 (as primer) must be attended to when applying on absorptive substrates such as gypsum plaster and Score Tech's staff should be consulted before tile fixing to confirm the suitability of the tile adhesive material to be applied on such substrate.

#### Mixing:

Open the lid of pail containing Tilex P10 and the material is ready-to-use. Gently stir the paste if necessary. If the pail lid for Tilex P10 is left opened for substantial time and a thin polymer film is formed on the surface, re-stir the paste to restore its consistency before use. Do not use over-

dried paste and do not add water to the paste to restore its workability.

#### INSTALLATION:

1. Moist the substrate before applying Tilex P10 to fix the tiles.
2. Spread Tilex P10 with a straight edge or trowel onto the substrate with reasonable area that can be fixed with tiles within the open time of the material. Use a notched trowel to comb the material with a cross action forming keys suitable for tile fixing.
3. Butter a thin coating of adhesive over the back of tiles to fill the ribs or keys.
4. Place and press tiles onto the material for fixing them in position on the combed adhesive bed to spread the adhesive evenly over the back of tile. Use the handle of the trowel or hammer to gently adjust the level of the tile and check the alignment with level gauge.
5. Form joints to width specified against respective tile sizes.
6. Grout up joints with Tilex G5 (tile grout) in accordance with the recommendation given in the data sheet of Tilex G5.

#### CURING:

Under normal circumstances, natural curing for Tilex P10 is proven to be adequate.

#### Packaging

Tilex P10 is available in 4 & 11 kg pails.

#### Storage

Tilex P10 has a minimum shelf life of 6 months provided the temperature is kept within the range of 5°C to 35°C in a dry store in the original, unopened packs. The shelf life will be reduced at higher ambient temperatures.

#### Precautions

##### Health and safety:

Tilex P10 is non-toxic and does not contain hazardous material and should not come into contact with skin and eyes. Avoid inhalation of dust during mixing. Gloves, goggles and dust mask should be worn. If contact with skin occurs, wash with water. Splashes to eyes should be washed immediately with plenty of clean water and medical advice sought.

##### Fire:

Tilex P10 is non-flammable.

# Resincoat®

## Flexible acrylic polymer modified protective & decorative coating for concrete & masonry

### Uses

To protect atmospherically exposed reinforced concrete structures from attack by acid gases, chloride ions, oxygen and water. The product is also suitable to protect other cementitious substrates and masonry. It is suitable for use on all types of structures, including those in coastal environments. It is equally suitable for new and existing structures.

The product is designed to re-face and even out variations in concrete and masonry surfaces and bridge shrinkage cracks. It provides a seamless, flexible waterproof coating which is suitable for water tanks, reservoirs and rooves. The product provides a tough durable wear resistant coating which can withstand light pedestrian traffic, has excellent weather resistance for exterior applications and provides a decorative function.

### Advantages

- Excellent barrier to carbon dioxide, chloride ions & water
- Allows water vapour to escape from the structure
- Waterproof – Suitable for water retaining structures
- High resistance to the effects of long-term weathering, durable in all climatic conditions including UV attack
- Minimum surface preparation needed low labour costs
- Non toxic – Ideal for potable water tanks
- Flexible, with thermal expansion similar to concrete
- Covers honeycombed&pitted poured concrete effectively

### Description

Resincoat comprises a two component acrylic polymer modified cementitious coating supplied in ready mix kits. It requires only the site addition of clean water to produce an easily Resincoat coating. Resincoat can be simply applied by stiff brush, roller, spray or trowel to obtain the desired texture.

### Properties

Appearance	Gray&White Cementitious Powder (special colours on request)
Coverage	Brush applied: 18 – 20 m <sup>2</sup> per kit / 1 coat Spray applied: 22 – 24 m <sup>2</sup> per kit / 1 coat Trowel applied: 14 – 16 m <sup>2</sup> per kit / 1 coat
Application temp.	Not less than 5°C

### Specification clauses

The protective coating shall comprise specially selected cements, graded hardwearing aggregates and additives supplied in powder form together with a liquid component of blended acrylic co-polymers and wetting agents. The total dry film thickness of the coating shall not be less than 2 mm

and shall be capable of providing resistance to wear and weather and good chemical resistance to mild inorganic acid solution, diesel oil, gasoline, chlorides, de-icing salts, effluents and organic solvents. It shall exhibit positive water pressure resistance up to 7 metre head, dependent on coating thickness.

### Instructions for use

#### Surface preparation:

All surfaces should be dry and free from contamination such as oil, grease, loose particles, delayed matter, moss, algal growth, laitance and all types of mould release oils and curing compounds. This is best achieved by lightly grit blasting the surface. Where moss, algae or similar growths have occurred, treatment with a proprietary biocide should be carried out after the grit-blasting process. Spalled and deeply disintegrated concrete should be removed to sound concrete and repaired with a Capco repair system.

#### Mixing:

Resincoat liquid concentrate should be poured from the plastic container in to the metal drum provided. An equal volume (1 to 2 litres) of clean fresh water is added for brush application consistency and mixing commenced with a propeller agitator attached to a slow speed drill (500 r.p.m.). The powder component should be added gradually to the liquid to avoid lump formation and mixed for 2 to 4 minutes. Resincoat should be immediately used after mixing.

Do not mix more material than can be used within the pot life. Keep mixing Resincoat during the application.

Mixing ratio: powder: Liquid: Water: 10: 4: 1 to 2 (kg)

#### Application:

For best results, surface should be damp. In order to obtain the protective properties of Resincoat, it is important that the correct rates of application are observed. Use a short stiff brush preferably 120 – 200 mm width and apply in one or two coats as required.

Spray or trowel applications should use the correct mixing ratio to obtain satisfactory consistency. In hot climatic conditions, it is likely that spray application will be the best for exterior decorative finishes. Nozzle size should be 3 - 4 mm and pressure of 6 – 8 bars should be used.

The application of Resincoat should not commence if the temperature of the substrate is below 5°C. Application of Resincoat on hot substrates, i.e. over 40°C surface temperature will need the application of a primer coat of mixed Resincoat and water in slurry like consistency and supply Resincoat over the primer whilst it is still wet.

It is recommended that for general resurfacing each coat should be 1 mm thickness. Areas subjected to light foot traffic should receive at least 2 mm thickness of Resincoat and an additional 2 mm should be applied if conditions are moderate to heavy pedestrian traffic.

#### Cleaning:

Immediately following the application of Resincoat, clean all

# Resincoat<sup>®</sup>

tools and equipment with clean water. Cured material can only be removed mechanically.

## Limitations

Resincoat is formulated for application to clean, sound concrete or masonry. Where subsequent coatings or paints are required, trials should be conducted to ensure compatibility. Resincoat is compatible with most forms of subsequent coating. Compatibility and soundness should be assessed on a trial area.

Application of Resincoat should not commence if the temperature of the Resincoat is below 5°C. Resincoat should not be applied where there is a likelihood of exposure to frost within 48 hours of the application. The product should not be applied in windy conditions where early age dust adhesion may occur, or where rain is likely within 2 hours at 20°C or 20 hours at 5°C (up to 80% RH). It should not be applied when the prevailing relative humidity exceeds 90%.

## Packaging

14 kg packs consist of:

Powder: 14 kg bag

Liquid: 4 kg container

## Storage

Resincoat has a minimum shelf life of 6 months at 35°C if kept in a dry store in the original, unopened packs. The shelf life will be reduced at higher ambient temperatures.

## Precautions

### *Health and safety:*

Resincoat is alkaline and should not come into contact with skin and eyes. Avoid inhalation of dust during mixing. Gloves, goggles and dust mask should be worn. If contact with skin occurs, wash with water. Splashes to eyes should be washed immediately with plenty of clean water and medical advice sought.

### *Fire:*

Resincoat is non-flammable.

# Powdercoat®

## Crystalline capillary waterproofing for concrete substrates

### Uses

Powdercoat is an economical cementitious coating system designed for waterproofing concrete against positive or negative hydrostatic water pressure in a wide variety of structures such as:

- Sewage treatment and water treatment plants
- Water tanks
- Concrete pipes
- Manholes

### Advantages

- Penetrates concrete, seals capillary tracts & hairline cracks
- Contains no chlorides
- Easy to apply, cost effective in use
- Can be applied to new or old concrete in both interior and exterior locations
- Suitable above or below ground
- Surface damage will not affect the system

### Description

Powdercoat crystalline capillary waterproofing system is a blend of proprietary Portland cements, quartz aggregates and specialized chemicals. In the presence of moisture, the active chemical additives in Powdercoat penetrate concrete and react chemically with free lime to produce insoluble crystals. This crystalline growth reduces concrete porosity by blocking capillaries and filling hairline cracks caused by shrinkage or expansion. Unlike membrane types of waterproofing which only provide a surface barrier, Powdercoat continues to produce crystals in the presence of water therefore providing long lasting impermeability.

### Properties

Appearance	Gray & White Cementitious Powder
Coverage	1.2-1.3 kg/m <sup>2</sup> per application

### Instructions for use

#### Preparation:

- Old concrete

Concrete surfaces must be clean, sound and free from any contamination which may interfere with application process. Cleaning can be achieved by high pressure water jetting. High pressure water jetting is preferred method of surface preparation because mechanical cleaning, surface saturation & substrate roughening are simultaneously

achieved. All surfaces to receive Powdercoat must be pre-dampened.

- New concrete

Following stripping of formwork, water jet or acid etch as above to remove all traces of form oil and surface laitance. Remove all debris from the work area before proceeding with thorough saturation (with clean potable water) of the area prior to the next stage of the works.

#### Mixing:

##### Slurry consistency

Add clean potable water to Powdercoat at the rate of 8 litres/25 kg bag of Powdercoat. Mix thoroughly using a slow speed drill (300 - 500 rpm) & recommended mixing paddle until a creamy consistency is achieved. For mortar consistency, reduce water addition to 3.7 - 4.4 litres of clean potable water per 25 kg of Powdercoat, following mixing instructions identified above. Do not mix more material than can be safely used in 20 minutes at 25°C and 50% RH. If the mixture thickens, re-stir to reduce consistency, do not add water.

#### Application:

- Dry shake for newly poured concrete

Use Powdercoat directly from the bag. Wearing rubber gloves, distribute the powder evenly by hand over freshly poured concrete at the rate of 1.2-1.3 kg/m<sup>2</sup> per application, before final troweling works. It is recommended to evenly distribute 50% of the powder in one direction with the remaining 50% at right angles to the first application. Release the powder as close to the wet concrete as possible, this will minimize powder loss during windy conditions. For large areas, a rotary type spreader may prove beneficial. Two applications are recommended, with a roughened finish on the first application providing adequate adhesion of the second application. Finally, trowel finish to the desired profile.

- Slurry coat for existing concrete

Powdercoat slurry coat can be applied with a soft brush, broom, or plaster sprayer. Ensure the slurry is worked well into openings, rough surfaces, joints and routed out areas. Make the second application when the first coat has reached initial set (usually within one hour dependent upon temperature). If the first coat has dried out, moisten

# Powdercoat<sup>®</sup>

the surface prior to applying the second coat. Active water leaks should be pre-sealed by using a rapid setting plugging mortar Watercut (see separate data sheet), prior to application of Powdercoat.

## **Curing and protection:**

Powdercoat applications must be kept moist for a minimum of 48 hours therefore following initial set, curing by water spraying is recommended. The treated surface shall be 'fog' sprayed a minimum of 3 to 4 times daily for the 48 hour period. In warmer climates, it is recommended to spray more frequently whereby the treated surface is kept constantly moist.

It is important to keep the treated substrate moist to allow crystal formation to occur. Protect surfaces from foot traffic for 48 hours or heavy traffic for 7 days. Freshly applied Powdercoat must be protected from extreme weather conditions such as strong winds, high temperatures, rain and freezing for a period of not less than 48 hours following app

## **Cleaning:**

Immediately following the application of Powdercoat, clean all tools and equipment with clean water. Cured material can only be removed mechanically.

## **Limitations**

- Powdercoat should not be used when the temperature is 5°C and falling
- Full activation & effectiveness of Powdercoat may require 2 - 3 weeks following application

## **packaging**

Powdercoat is available in 25 kg bags.

## **Storage**

Powdercoat has a minimum shelf life of 6 months at 35°C if kept in a dry store in the original, unopened packs. The shelf life will be reduced at higher ambient temperatures.

## **Precautions**

### **Health and safety:**

Powdercoat is alkaline and should not come into contact with skin and eyes. Avoid inhalation of dust during mixing. Gloves, goggles and dust mask should be worn. If contact with skin occurs, wash with water. Splashes to eyes should

be washed immediately with plenty of clean water and medical advice sought.

### **Fire:**

Powdercoat is non-flammable.

# Silcoat<sup>®</sup> W

## Non-Film Forming Water Repellent Sealer

### Uses

To protect atmospherically exposed reinforced concrete structures from attack by chloride ions and water intrusion. The product is also suitable to protect other cementitious substrates and masonry.

Silcoat W is suitable for use on all types of structures, including those in coastal environments. It is equally suitable for new and existing structures.

Silcoat W waterproofing sealer is particularly suitable for decorative, stained or exposed-aggregate concrete and for natural stone, bricks and pavers. Resists water, deicing salts, and gasoline.

### Advantages

- Penetrates into substrates
- Non staining
- Reduces water and chloride intrusion Increases freeze thaw resistance
- Minimizes efflorescence
- Allows water vapour to escape from the structure
- Chemically resistant to ice melting compounds, fuels, oils and atmospheric contaminants

### Description

Silcoat W is a single component penetrating silane-siloxane system which penetrates into porous substrates and then reacts to produce a bonded hydrophobic lining to the pores.

Although allowing passage of water vapour from the substrate it significantly reduces the absorption of water and water borne salts.

Silcoat W does not discolour most substrates and has excellent resistance to weathering.

### Properties

Appearance	Colorless liquid
Specific Gravity	Approx. 1.05 gr/cm <sup>3</sup> @ 20°C

### Instructions for use

#### Preparation:

All surfaces should be dry and free from contamination such as oil, grease, loose particles, decayed matter, moss, algal growth, laitance and all traces of mould release oils and curing compounds. This is best achieved by lightly sand-blasting the surface. Where moss, algae or similar growths have occurred, treatment with a proprietary biocide should be carried out after the sand-blasting process.

#### Application:

In order to obtain the penetrating properties of Silcoat W, it is important that the correct rates of application and overcoating times are observed.

Number of coat	2
Theoretical application rate per coat	0.2 kg/m <sup>2</sup>
Overcoating time	2 hours @ 20°C

Silcoat W should be applied in two flood coats until the recommended total application rate of 0.4 litre per square metre has been achieved. This is best accomplished by using portable spray equipment of the knapsack-type. Silcoat W should be allowed to dry for a minimum of 2 hours (@ 20°C) before continuing.

#### Cleaning:

Silcoat W should be removed from tools and equipment after use.

### Packaging

Silcoat W is available in 20 kg containers.

### Storage

When stored in the original unopened container in cool, dry conditions away from sources of heat and naked flames, Silcoat W will have a shelf life of 12 months.

If stored at high temperatures and/or high humidity conditions the shelf life will be reduced.

### Precautions

#### Health and safety:

Silcoat W does not fall into the hazard classifications of current regulations. However, it should not be swallowed or allowed to come into contact with skin and eyes.

Suitable protective gloves and goggles should be worn.

Splashes on the skin should be removed with water. In case of contact with eyes rinse immediately with plenty of water and seek medical advice. If swallowed seek medical attention immediately - do not induce vomiting.

#### Fire:

Silcoat W is non-flammable.

# Watercut®

## Rapid setting cement based, water-stopping mortar

### Uses

For the rapid temporary patching and plugging of concrete segments, concrete & brick tunnel linings, sewage systems, below ground access chambers, pipes, basements, foundations and mines.

### Advantages

- Emergency water-stopping capability
- Single component - only requires addition of clean water
- Excellent bond to the substrate
- Low exotherm minimizes thermal cracking
- Pre-bagged formulation to overcome variations in site batching
- Contains no chloride admixtures

### Description

Watercut is supplied as a ready to use blend of dry powders which requires only the site addition of clean water to produce a highly consistent, rapid setting mortar which is easy to apply in many difficult conditions. The material is based on a blend of cements, graded aggregates, special fillers and chemical additives which control the rate of set and minimize the risk of thermal cracking. Watercut provides an initial set time of approximately one minute.

### Properties

Appearance	Gray Cementitious Powder
Initial set time	Approx. 3 minute @ 20°C

### Instructions for use

#### Preparation:

Areas to be patched should be cut back to a depth of 15 mm and given a good mechanical key. Feather-edges must not be allowed. Surface should be brushed clean to remove loose material, dust and laitance. Grease, slime or mould growth should be removed by steam cleaning or high-pressure water jetting.

A proprietary degreasing agent should be used for removal of light oil or grease contamination. To seal leaks, crack openings must be chased out to approximately 20 mm square. The chase should always be undercut to avoid leaving a v-section. All loose material and debris should be removed.

#### Mixing:

Watercut should be added to clean water in the following proportions:

One part clean water: 3 parts Watercut (measured by volume). Mix to a stiff consistency in a suitable mixing drum or bucket, using a trowel or gloved hand. Due to the rapid set characteristics of the product, only prepare a quantity of mortar which can be placed within the prescribed set time.

#### Application:

Trowel apply or hand-knead the mixed mortar in place, ensuring maximum contact with the substrate before the material sets. If being used to plug running water, Watercut

should be used and held in place until the initial set is reached.

Note: The minimum applied thickness of Watercut should be 15 mm.

#### Cleaning:

Watercut products should be removed from tools, equipment and mixers with clean water prior to the initial set. Cured material can only be removed mechanically.

#### Limitations

Watercut should not be used when the temperature is below 1°C and falling.

### packaging

Watercut is available in 25 kg bags.

### Storage

Watercut has a minimum shelf life of 6 months at 35°C if kept in a dry store in the original, unopened packs. The shelf life will be reduced at higher ambient temperatures.

### Precautions

#### Health and safety:

Watercut is alkaline and should not come into contact with skin and eyes. Avoid inhalation of dust during mixing. Gloves, goggles and dust mask should be worn. If contact with skin occurs, wash with water. Splashes to eyes should be washed immediately with plenty of clean water and medical advice sought.

#### Fire:

Watercut is non-flammable.



# Softcoat®

## Shrinkage Compensated, Fibre Reinforced, Repair Mortar System

### Uses

Softcoat is suitable for sprayed or trowelled applications, with high build characteristics.

Typical applications would include, but not be limited to, the following:

- All types of structural repair which can be applied by trowel or wet spray
- Repair of structural members subjected to repetitive loading including application in trafficked areas
- Repairs to reinforced or pre-stressed beams or columns
- Repairs in industrial area, especially those containing mineral oils, lubricants etc
- Repairs in marine environments

### Advantages

- Wet or dry spray application- rapid application of large quantities
- Low rebound - when dry spray applied rebound is minimal with subsequent saving in material cost
- Low permeability - gives excellent resistance to attack by aggressive elements

### Description

Softcoat is supplied as a ready to use blend of dry powders, which requires only the addition of clean water to produce a highly consistent cementitious repair mortar suitable for structural concrete and masonry repairs.

Softcoat contains no metallic aggregate and is chloride free. Softcoat is formulated for sprayed or trowelled applications, in thicknesses upto 30 mm in one layer by hand application. Greater thicknesses can be achieved when spray applied.

### Properties

Appearance	Gray Cementitious Powder	
Compressive strength (MPa) (ASTM C109/109M-02)	1 Day	25
	7 Days	45
	28 Days	60
Flexural strength (MPa) (BS6319, Part 3 : 1998)	1 Day	3.5
	7 Days	7
	28 Days	9.5
Bond Strength (MPa) (BS 1881, Part 207)	> 0.5	
Application temperature	5 - 40°C	
Water permeability (DIN 1048)	< 10 mm	

### Instructions for use

#### Preparation:

It is essential that the substrate to be repaired is sound, clean and free of all contamination.

The damaged areas of concrete to be removed must be clearly identified. The Perimeter of the area should be saw cut to a depth of 10 mm and the edges cut as neatly as possible keeping the sides square.

Feather-edging is not permitted and a minimum thickness

of 10 mm must be maintained over the whole area. The substrate should be prepared to provide a rough surface having at least 5 mm amplitude at 20 mm frequency.

If unsound or oil contaminated concrete is found to extend beyond the pre-marked area, consult the engineer in charge. Subject to approval cut back to clean sound concrete.

If reinforcement is corroded ensure that the back of the steel has been exposed. Reinforcement should have all rust removed by the use of power tools, abrasive blasting (wet or dry) or wire brushing.

#### Water Saturation:

Thoroughly saturate the surface of the concrete to provide a saturated surface dry condition. Poor quality concrete may require soaking for a significant length of time. Any surface water should be removed using an oil free compressed air-jet.

#### Mixing:

Softcoat should be mixed mechanically with a Heavy Duty, slow speed drill or a forced action mixer fitted.

Add 3 litres of water into a suitably sized mixing vessel for full bag mixing. Do not use part-bags. It is suggested that the temperature of the water should not exceed 20°C, so that the temperature of the final mixed material is not greater than 30°C.

With the mixer in action, add one full bag of Softcoat and mix for 3 - 5 minutes, until the mix becomes fully homogeneous. (Water levels may be adjusted to allow good spray techniques between 3 & 3.5 litres per bag)

#### Application:

After mixing, Softcoat can be sprayed or trowel applied. When applying by hand, Softcoat must be forced tightly into the substrate to ensure intimate contact with the pre-wetted substrate.

Leveling and initial finishing should be carried using a wooden or plastic float. Final finishing should be carried out using a steel float.

When the material has stiffened to the point where finger pressure lightly marks the surface, a final firm troweling should be given using a steel float.

#### Curing:

Softcoat demands good curing. Particular care is required in hot/windy conditions. Curing is to be commenced immediately either by applying a single coat of Capcobond MO40 or by covering the work with plastic sheet fixed over wet hessian and taped at all edges.

#### Cleaning:

Softcoat should be removed from tools and equipment with clean water immediately after use.

#### Limitations

- Softcoat should not be used when the ambient temperature is below 5°C and falling
- Softcoat should not be exposed to running water either during application or prior to final set

# Softcoat®

## Packaging

Softcoat is available in 25 kg bags.

## Storage

Softcoat has a minimum shelf life of 12 months at 20°C if kept in a dry store in the original, unopened packs. The shelf life will be reduced at higher ambient temperatures.

## Precautions

### **Health and safety:**

Softcoat is alkaline and should not come into contact with skin and eyes. Avoid inhalation of dust during mixing. Gloves, goggles and dust mask should be worn. If contact with skin occurs, wash with water. Splashes to eyes should be washed immediately with plenty of clean water and medical advice sought.

### **Fire:**

Softcoat is non-flammable.

# Softcoat® RP

## Shrinkage Controlled, Vertical and Overhead Cementitious Waterproof Repair Mortar

### Uses

Softcoat RP is suitable for hand application to repairs where light to medium load bearing is required. Typical applications would include, but not be limited to, the following:

- Vertical and overhead repairs
- General concrete and masonry repairs
- Larger scale repairs where formwork cannot be erected.

### Advantages

- Extremely low permeability - gives excellent resistance to attack by aggressive elements
- Excellent bond to concrete substrate
- Shrinkage compensated
- Contains no chloride admixtures

### Description

Softcoat RP is supplied as a ready to use blend of dry powders, which requires only the addition of clean water to produce a highly consistent cementitious repair mortar suitable for general purpose concrete and masonry repairs. Softcoat RP contains no metallic aggregate and is chloride free.

Softcoat RP is formulated for sprayed or trowelled applications, in thicknesses upto 30 mm in one layer by hand application. Greater thicknesses can be achieved when spray applied.

### Properties

Appearance	Gray Cementitious Powder	
Compressive strength (MPa) (ASTM C109/109M-02)	7 Days	35
	28 Days	45
Flexural strength (MPa) (BS6319, Part 3 : 1998)	7 Days	6
	28 Days	9
Bond Strength (MPa) (BS 1881, Part 207)	> 1.5	
Application temperature	5 - 40°C	
Water permeability (DIN 1048)	< 7 mm	
Water absorption (BS 1881, Part 121)	< 2%	

### Instructions for use

#### Preparation:

It is essential that the substrate to be repaired is sound, clean and free of all contamination.

The damaged areas of concrete to be removed must be clearly identified. The Perimeter of the area should be saw cut to a depth of 10 mm and the edges cut as neatly as possible keeping the sides square.

Feather-edging is not permitted and a minimum thickness of 10 mm must be maintained over the whole area. The

substrate should be prepared to provide a rough surface having at least 5 mm amplitude at 20 mm frequency.

If unsound or oil contaminated concrete is found to extend beyond the pre-marked area, consult the engineer in charge. Subject to approval cut back to clean sound concrete.

If reinforcement is corroded ensure that the back of the steel has been exposed. Reinforcement should have all rust removed by the use of power tools, abrasive blasting (wet or dry) or wire brushing.

#### Water Saturation:

Thoroughly saturate the surface of the concrete to provide a saturated surface dry condition. Poor quality concrete may require soaking for a significant length of time. Any surface water should be removed using an oil free compressed air-jet.

#### Mixing:

Softcoat RP should be mixed mechanically with a Heavy Duty, slow speed drill or a forced action mixer fitted.

Add 3 litres of water into a suitably sized mixing vessel for full bag mixing. Do not use part-bags. It is suggested that the temperature of the water should not exceed 20°C, so that the temperature of the final mixed material is not greater than 30°C.

With the mixer in action, add one full bag of Softcoat RP and mix for 3 - 5 minutes, until the mix becomes fully homogeneous. (Water levels may be adjusted to allow good spray techniques between 3.5 & 4.5 litres per bag)

#### Application:

After mixing, Softcoat RP can be sprayed or trowel applied. When applying by hand, Softcoat RP must be forced tightly into the substrate to ensure intimate contact with the pre-wetted substrate.

Leveling and initial finishing should be carried using a wooden or plastic float. Final finishing should be carried out using a steel float.

When the material has stiffened to the point where finger pressure lightly marks the surface, a final firm troweling should be given using a steel float.

#### Curing:

Softcoat RP demands good curing. Particular care is required in hot/windy conditions. Curing is to be commenced immediately either by applying a single coat of Capcobond MO40 or by covering the work with plastic sheet fixed over wet hessian and taped at all edges.

#### Cleaning:

Softcoat RP should be removed from tools and equipment with clean water immediately after use.

#### Limitations

- Softcoat RP should not be used when the ambient

# Softcoat<sup>®</sup> RP

temperature is below 5°C and falling

- Softcoat RP should not be exposed to running water either during application or prior to final set

## Packaging

Softcoat RP is available in 25 kg bags.

## Storage

Softcoat RP has a minimum shelf life of 12 months at 20°C if kept in a dry store in the original, unopened packs. The shelf life will be reduced at higher ambient temperatures.

## Precautions

### **Health and safety:**

Softcoat RP is alkaline and should not come into contact with skin and eyes. Avoid inhalation of dust during mixing. Gloves, goggles and dust mask should be worn. If contact with skin occurs, wash with water. Splashes to eyes should be washed immediately with plenty of clean water and medical advice sought.

### **Fire:**

Softcoat RP is non-flammable.

# Softcoat® AP

## Two Component, Polymer Modified Cementitious Waterproof Repair Mortar

### Uses

Softcoat AP is designed for application to imperfections in concrete and masonry surfaces in wet Area.

It is suitable for application in the range 5 to 25 mm, and can be used in the following situations:

- Concrete repair in marine climates
- General reprofiling over large areas
- Filling blow holes prior to overcoating
- Vertical repairs

### Advantages

- Low permeability provides good protection against carbon dioxide and chlorides
- Excellent bond to concrete substrate
- Formulated for use in hot climates
- Shrinkage compensated
- Contains no chloride admixtures

### Description

Softcoat AP is supplied as a ready to use blend of dry powders, which requires only the addition of clean water to produce a highly consistent cementitious repair mortar suitable for general purpose concrete and masonry repairs.

Softcoat AP contains no metallic aggregate and is chloride free.

Softcoat AP is formulated for sprayed or trowelled applications; in thicknesses upto 25 mm in one layer by hand application. Greater thicknesses can be achieved when spray applied.

### Properties

Appearance	Gray Cementitious Powder	
Compressive strength (MPa) (ASTM C109/109M-2)	7 Days	30
	28 Days	60
Flexural strength (MPa) (BS 6319, Part 1998: 3)	7 Days	7
	28 Days	11
Bond Strength (MPa) (BS 1881, Part 207)	> 1	
Application temperature	5 - 30°C	
Water permeability (DIN 1048)	< 5 mm	
Water absorption (BS 1881, Part 121)	< 1%	

### Instructions for use

#### Preparation:

It is essential that the substrate to be repaired is sound, clean and free of all contamination.

The damaged areas of concrete to be removed must be clearly identified. The Perimeter of the area should be saw cut to a depth of 10 mm and the edges cut as neatly as possible keeping the sides square.

Feather-edging is not permitted and a minimum thickness

of 10 mm must be maintained over the whole area. The substrate should be prepared to provide a rough surface having at least 5 mm amplitude at 20 mm frequency.

If unsound or oil contaminated concrete is found to extend beyond the pre-marked area, consult the engineer in charge. Subject to approval cut back to clean sound concrete.

If reinforcement is corroded ensure that the back of the steel has been exposed. Reinforcement should have all rust removed by the use of power tools, abrasive blasting (wet or dry) or wire brushing.

#### Water Saturation:

Thoroughly saturate the surface of the concrete to provide a saturated surface dry condition. Poor quality concrete may require soaking for a significant length of time. Any surface water should be removed using an oil free compressed air-jet.

#### Mixing:

Softcoat AP should be mixed mechanically with a Heavy Duty, slow speed drill or a forced action mixer fitted.

Add 2 litres of water into a suitably sized mixing vessel for full bag mixing. Do not use part-bags. It is suggested that the temperature of the water should not exceed 30°C, so that the temperature of the final mixed material is not greater than 35°C.

With the mixer in action, add one full bag of Softcoat AP and mix for 2 - 3 minutes, until the mix becomes fully homogeneous. (Water levels may be adjusted to allow good spray techniques between 4.5 & 5.5 litres per bag)

#### Application:

After mixing, Softcoat AP can be sprayed or trowel applied. When applying by hand, Softcoat AP must be forced tightly into the substrate to ensure intimate contact with the pre-wetted substrate.

Leveling and initial finishing should be carried using a wooden or plastic float. Final finishing should be carried out using a steel float.

When the material has stiffened to the point where finger pressure lightly marks the surface, a final firm troweling should be given using a steel float.

#### Curing:

Softcoat AP demands good curing. Particular care is required in hot/windy conditions. Curing is to be commenced immediately either by applying a single coat of Capcobond MO40 or by covering the work with plastic sheet fixed over wet hessian and taped at all edges.

#### Cleaning:

Softcoat AP should be removed from tools and equipment with clean water immediately after use.

#### Limitations

- Softcoat AP should not be used when the ambient temperature is below 5°C and falling
- Softcoat AP should not be exposed to running water either during application or prior to final set

# Softcoat<sup>®</sup> AP

## Packaging

24 kg packs consist of:  
Powder: 20 kg bag  
Liquid: 4 kg container

## Storage

Softcoat AP has a minimum shelf life of 6 months at 20°C if kept in a dry store in the original, unopened packs. The shelf life will be reduced at higher ambient temperatures.

## Precautions

### **Health and safety:**

Softcoat AP is alkaline and should not come into contact with skin and eyes. Avoid inhalation of dust during mixing. Gloves, goggles and dust mask should be worn. If contact with skin occurs, wash with water. Splashes to eyes should be washed immediately with plenty of clean water and medical advice sought.

### **Fire:**

Softcoat AP is non-flammable.

# Hardfloor<sup>®</sup>

## Surface Hardening Powder for Fresh Concrete Floors

### Uses

Hardfloor provides a highly abrasion resistant surface to fresh concrete floors by the dry shake method which ensures that the hard wearing surface bonds monolithically to the base concrete. It is ideally suited for all industrial areas subjected to heavy traffic such as: power stations, heavy industry, agricultural building, distillation plants, laboratories, car parks, abattoirs, warehouse floors and loading bays & work shops.

### Advantages

- Supplied ready to use - no additives required
- Provides a hard, abrasion resistant surface
- Forms monolithic bond with fresh concrete base
- Hard, dense surface resistant to oils and grease
- Range of colours - improve working environment
- Non-metallic aggregate - will not rust when wet

### Standards compliance

Floors shall be surfaced where shown with Hardfloor, a monolithic surface hardening compound containing nonmetallic, rust-free aggregates. The aggregate shall have a value more than 8 on Mohs original scale & the compound shall have the ability to improve the abrasion resistance of concrete by 200%. Hardfloor powder shall be applied to the freshly-laid concrete floor by the dry-shake method. It shall be applied at the point where light foot traffic leaves an imprint of about 3 - 6 mm. Powder shall be applied in 2 stages, in full accordance with the manufacturer's instructions, to achieve an overall application rate not less than 5 kg/m<sup>2</sup>. Special attention shall be paid to bay edges in accordance with the manufacturer's written requirements.

### Design Criteria

**Base concrete:** The base concrete should have a minimum cement content of 300 kg/m<sup>3</sup>. The concrete mix should be designed to minimize segregation and control bleeding, although some limited bleed is desirable to ensure sufficient moisture is available to wet out Hardfloor when it is first applied. The use of water reducing admixtures from Capco Plastit\* range is strongly recommended in order to achieve a water:cement ratio below 0.55. The base concrete should have an on-site slump of between 75 and 100 mm. The base concrete should be laid and compacted in accordance with good concrete practice, taking care to ensure accurate finished profile and minimum laitance build up. Particular attention should be paid to bay edges and corners to ensure full compaction of the base concrete – see Instructions for use, Bay edges. Vacuum dewatering is not recommended.

### Description

Hardfloor surface hardening compound is a quality controlled, factory blended powder which is ready to use on site. It consists of special hard wearing emery aggregates selected for their physical properties of abrasion and wear resistance, Portland cement and special additives to improve workability. This combination produces a material

which is easy to trowel in the surface of fresh, wet concrete. Hardfloor cures monolithically to provide a dense, non porous surface which is extremely hard wearing and abrasion resistant. Monolithic cure ensures that problems normally associated with thin ('granolithic') screeds, e.g. curling, shrinkage, cracking, etc. are completely overcome.

### Properties

**Abrasion resistance:** The abrasion resistance of Hardfloor has been tested using a taber abrasion machine (fitted with 1 Kg, H-22 wheels) showing that Hardfloor improves the abrasion resistance of concrete by minimum 200%.

**Compressive strength (BS 1881, Part 116 1983):** At water contents equivalent to those obtained in practical applications, the typical 28 day compressive strength of Hardfloor cubes is 70 N/mm<sup>2</sup>.

**Hardness (Mohs' scale):** The selected aggregates contained within Hardfloor have a hardness value of 8 on the Mohs original scale.

### Instructions for use

Hardfloor should be applied at an even application rate of 5 kg/m<sup>2</sup>. It is recommended that the floor should be marked off into bays of known area. Sufficient materials should then be laid out to meet the recommended spread rate. Application of Hardfloor should begin without delay when the base concrete has stiffened to the point when light foot traffic leaves an imprint of about 3 - 6 mm. Any bleed water should now have evaporated, but the concrete should have a wet sheen. On large floors it will be necessary to work progressively behind the laying team to ensure application at the correct time. Hardfloor is applied in two stages:

- a)** The first application is broadcast at an even rate of 3 kg/m<sup>2</sup> onto the concrete surface. When the material becomes uniformly dark by the absorption of moisture from the base concrete, this first application can be floated. Wooden floats or, on large areas, a power float, may be used. It is important, however, that the surface is not overworked.
- b)** Immediately after floating, the remaining 2 kg/m<sup>2</sup> of Hardfloor is applied evenly over the surface at right angles to the first. Again, when moisture has been absorbed the surface can be floated in the same way as before.

Final finishing of the floor using the blades of a power float can be carried out when the floor has stiffened sufficiently so that damage will not be caused.

**Bay edges:** Where bay edges are likely to suffer particularly heavy wear or impact and where saw-cut transverse control joints are to be located, it is desirable to give these areas additional protection, by one of the below methods prior to full treatment of the entire surface:

- a)** Immediately after leveling the freshly placed concrete, Hardfloor should be sprinkled by hand at a rate of 0.5 kg/lin.m. (5 kg/m<sup>2</sup>) in a strip 100 mm wide along the bay edge and hand-trowelled into the surface.

# Hardfloor<sup>®</sup>

**b)** Immediately after leveling the freshly placed concrete, remove a wedge of the concrete 10 mm deep at the slab edge and tapered up to slab level. Replace this with a very stiff paste of Hardfloor, mixed thoroughly with a small amount of water. Ensure it is fully compacted on to the base concrete.

These reinforced areas will be further strengthened when the subsequent full treatment is applied. Timing of the application of Hardfloor is important and care should be taken to ensure adequate labour, machinery and material is available to complete the whole area while sufficient moisture is available to fully react with the powder to provide a good dense finish. Conversely, the full benefit will not be achieved if the material is applied too early when bleed water is still present. Any addition of water to wet out the surface on either the first or second application of Hardfloor will be detrimental to the overall quality of the floor. Pigmented floors require extra care and need to be protected from damage and staining after completion. It is essential that the correct recommended rate of application is achieved over the entire floor area in order to avoid possible localized variations in shading.

## Curing & surface treatments & cleaning

Proper curing of concrete floors treated with Hardfloor is essential to physical properties of the finished floor. For indoor applications where curing conditions are less arduous and breakdown of curing membrane is slower alternative approved methods of curing such as polythene sheets taped at the edges is acceptable. Subsequent surface treatments are not normally necessary with Hardfloor because of the high density, low porosity finish. All equipment should be washed with clean water immediately after use and before material has hardened.

## Packaging

Hardfloor is available in 25 kg bags.

## Storage

Hardfloor has a minimum shelf life of 12 months at 20°C if kept in a dry store in the original, unopened packs. The shelf life will be reduced at higher ambient temperatures.

## Precautions

### **Health and safety:**

Hardfloor is alkaline and should not come into contact with skin and eyes. Avoid inhalation of dust during mixing. Gloves, goggles and dust mask should be worn. If contact with skin occurs, wash with water. Splashes to eyes should be washed immediately with plenty of clean water and medical advice sought.

### **Fire:**

Hardfloor is non-flammable.



# Densicoat®

## Concrete Surface Liquid Hardener & Densifier

### Uses

Densicoat is recommended for use wherever hardened, dustproofed, and improved chemical and abrasion resistant surfaces are required. Ideal applications include floors in industrial plants and warehouses, storage silos, sewage plants, chemical processing facilities, refineries, and heavy pedestrian floor traffic areas, such as civic centers, sports arenas, stadiums, hospitals, airports, and museums. Densicoat can successfully be used in conjunction with shake-on hardeners.

### Advantages

- Penetrates deeply into concrete to densify and harden surfaces to help prevent entry of moisture and other foreign matter
- Dustproofs and improves chemical, petroleum, and abrasion resistance of treated surfaces
- Provides a permanent, attractive sheen with the ability to polish
- Protects against scratching or peeling
- Provides tough, protected surface that won't after-yellow, discolor or show pedestrian or vehicular traffic wear marks
- Improves light reflectance
- Ready to use from container and easy to apply
- VOC content is 0 g/L.

### Description

Densicoat concrete densifier and chemical hardener compound is a ready-to-use, colorless liquid, formulated with chemically reactive raw materials to harden and dustproof concrete. When properly applied, Densicoat will offer substantial improvement in abrasion and chemical resistance and will significantly improve the durability of the concrete surface when compared to untreated concrete. As Densicoat is applied and penetrates into the concrete surface, a chemical reaction takes place, producing a byproduct that fills in the pores of the concrete. This process produces a substantially denser concrete surface with enhanced durability. In addition to the densifying and hardening action, Densicoat also solidifies the concrete, eliminating dusting and pitting.

### Properties

Appearance	Colorless liquid
Specific Gravity	Approx. 1.5 gr/cm <sup>3</sup> @ 20°C

### Instructions for use

#### Preparation:

- Fresh Concrete

On newly placed concrete, Densicoat can be applied, as you would a cure, after final troweling.

- Existing (Old) Concrete

Surface should be clean and structurally sound. Remove all residues, curing compounds, oils, sealers, contaminants and laitance before applying Densicoat. Fill and repair all holes, cracks and deteriorated areas that have been removed to sound concrete.

#### Application:

- Fresh Concrete

Apply undiluted Densicoat at approximately 5 m<sup>2</sup>/liter using a low-pressure sprayer or by spreading evenly with a soft-bristled broom. Do not allow material to puddle on the surface. No further application steps are required for fresh concrete.

- Existing (Old) Concrete

Saturate the surface with undiluted Densicoat by sprayer, squeegee or broom. Keep the surface wet with Densicoat for a minimum of 30 minutes. (A range of 30-60 minutes may be required depending on temperature and conditions.) NOTE: Pay particular attention to porous and/or dry areas. These areas must be kept wet at all times with Densicoat. Once the surface begins to gel and becomes slippery, immediately spray the surface with a light water mist. Scrub the surface with a broom or mechanical scrubber to increase the penetration of the Densicoat. Continue to work the Densicoat into the surface for another 5-10 minutes or until Densicoat becomes gelled and slippery for a second time. At this time, thoroughly flush the surface with water. During the flushing process, agitate the surface with a broom to aid in removal of the excess Densicoat. Remove all excess material with a mop or squeegee. Thoroughly squeegee the surface dry. If there are slippery patches, this is an indication that there is still excess Densicoat present. These areas should be re-flushed and squeegeed again until the entire surface is dry. (Extremely porous surfaces may require a second application.)

#### Burnishing:

Densicoat can be burnished to a high sheen on steel trowel concrete floors. A high-speed burnisher (2000-2200 rpm) with appropriate maintenance pad is needed.

#### Drying Time:

2 – 4 hours. Densicoat dries very quickly on new, virgin concrete. Drying times may be extended on existing (old) concrete due to surface conditions. Restrict foot traffic for at least four hours; 12 hours is preferable.

#### Cleaning:

While still wet, equipment may be cleaned quickly and easily with soap and water. Do not allow Densicoat to dry before flushing excess from surfaces.

### Packaging

Densicoat is available in 30 kg containers.

### Storage

When stored in the original unopened container in cool, dry conditions away from sources of heat and naked flames, Densicoat will have a shelf life of 12 months.

If stored at high temperatures and/or high humidity conditions the shelf life will be reduced.

# Densicoat<sup>®</sup>

## Precautions

### **Health and safety:**

Densicoat does not fall into the hazard classifications of current regulations. However, it should not be swallowed or allowed to come into contact with skin and eyes.

Suitable protective gloves and goggles should be worn.

Splashes on the skin should be removed with water. In case of contact with eyes rinse immediately with plenty of water and seek medical advice. If swallowed seek medical attention immediately - do not induce vomiting.

### **Fire:**

Densicoat is non-flammable.

# Fibercap<sup>®</sup> 12

## High performance polypropylene fibre

### Uses

Fibercap 12 is primarily used as a crack controlling additive for cementitious materials. Typical applications are:

- Crack control in readymix concrete, precast concrete, conventional shotcrete, screeds, rendering mortars, microsilica concrete
- Concrete slabs, pavements, driveways, imprinted concrete
- Water retaining structures, marine concrete etc.
- Patch repair, thin section walling etc.

### Advantages

- Cost effective - replaces anti crack wire mesh
- User friendly - decreases construction time and labour
- Versatile - Inhibits intrinsic cracking in concrete, improves finishing characteristics, concrete durability and acts as a rust proofers.
- Disperses uniformly throughout the mix & does not rust.

### Standards compliance

Fibercap 12 complies with requirements of ASTM C111.6

### Description

Fibercap 12, is a high performance polypropylene fibre, developed as a crack controlling additive for cementitious materials. It is available as monofilament 12mm in length for concrete and 6mm in length for plaster and mortar. It is used to inhibit the formation of small cracks which can occur through plastic shrinkage, premature drying and early thermal changes, in order to provide utilization of the intrinsic properties of the hardened cementitious material. Fibercap 12 is based on selected raw materials and manufactured under controlled conditions to give a consistent product.

### Properties

Form	Polypropylene Fibre
Size	12 mm
Specific gravity	0.91 gr/cm <sup>3</sup>
Alkali, Sulphate and Chloride content:	Nil
Fibre thickness	35 microns
Elastic modulus	3.5 GPa
5500 – 7000 MPa	345 N/mm <sup>2</sup>
Melting point	165 °C

### Dosage

The optimum dosage of Fibercap 12 to meet specific requirements should always be determined by trial mixes using the materials and conditions that will be experienced in use.

For normal concrete a dosage between 0.6 to 1.0 kg/m<sup>3</sup> may be used.

### Packaging

Fibercap 12 is available in 5 kg bags.

### Storage

Fibercap 12 has a minimum shelf life of 5 years at 35°C if kept in a dry store in the original, unopened packs.

### Precautions

#### Health and safety:

Fibercap 12 does not fall into the hazard classifications of current regulations. However, it should not be allowed to come into contact with skin.

#### Fire:

Fibercap 12 is flammable.

# Sealing Tapes

P.V.C Waterstops

Hydrophilic Waterstops

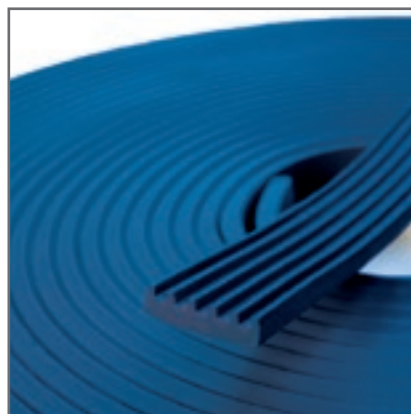

# Waterseal®

## High Quality P.V.C. Waterstops

### Description

The wide range of P.V.C waterstops are designed to provide an integral sealing system for movement and construction joints in concrete cast in-situ. These joints typically occur in the following types of structure.

### Typical Applications

For Construction and Expansion Joints, all Types of Joints in Transitions, Connections and Special Applications.

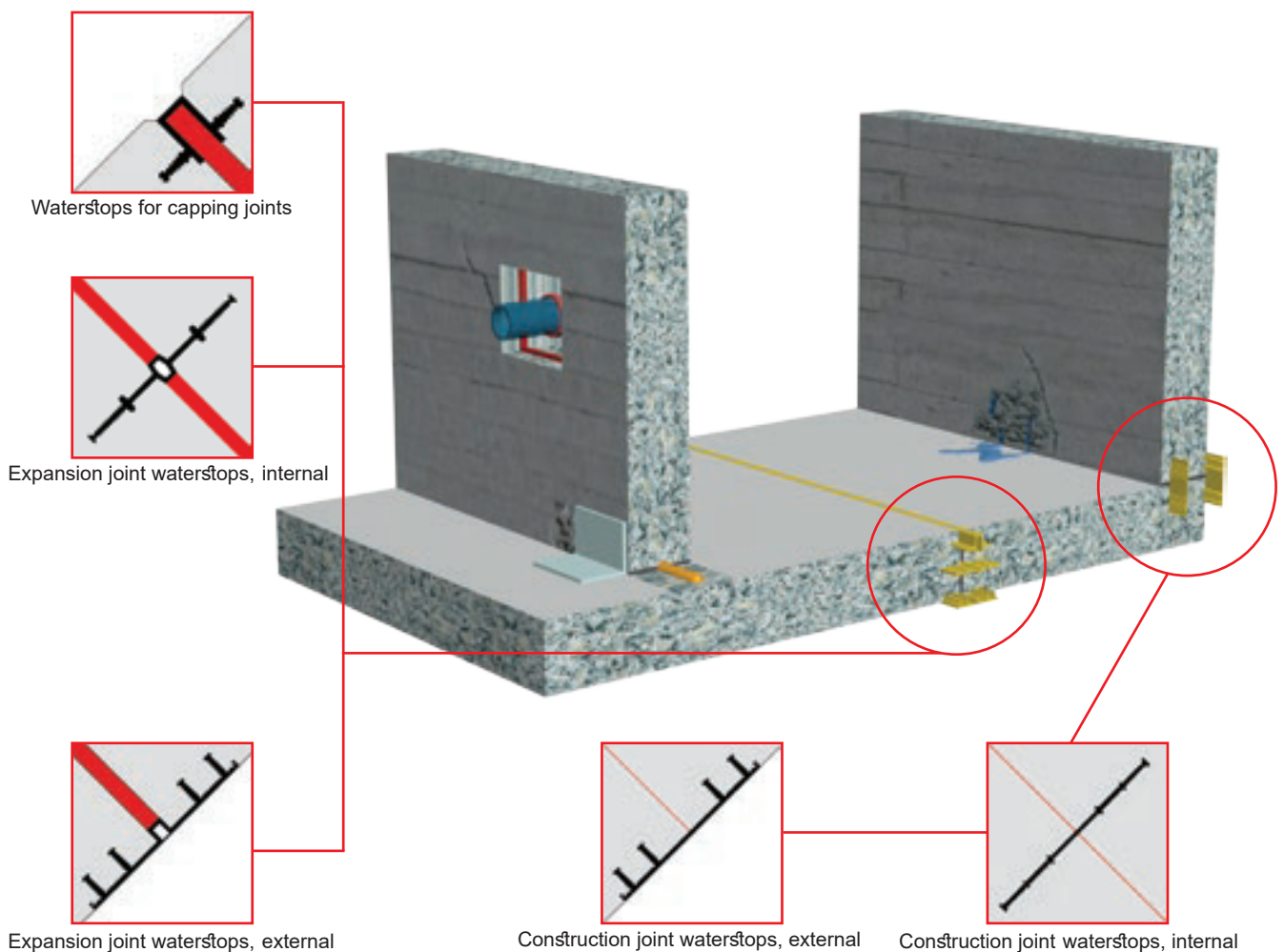

## Choose waterstops based on the type of joint

Type of Joint	Type of Waterstop	
Expansion Joints	Expansion joint waterstop, internal 	Expansion joint waterstop, external 
	Construction joint waterstop, internal 	Construction joint waterstop, external 

## Waterstop Design and Function

Type of waterstop	Waterstop Design and Function
Expansion joint waterstop, internal	
Expansion joint waterstop, external	

## Standards compliance

Waterseal produced in accordance with the requirements of DIN 18541 Part 2 (Physical Properties) and DIN 18541 Part 1 (Dimensional Properties).

### Physical Properties:

Physical Properties (DIN 18541 Part 2)			
No.	Property	DIN Standard	Requirement
1	Tensile strength in N/mm <sup>2</sup>	53455	≥10
2	Elongation at break in %	53455	≥350
3	Shore Hardness	53505	67±5
4	Tear strength in N/mm <sup>2</sup>	53507	≥12
5	Behaviour at low temperatures (-20°C), Elongation at break in N/mm <sup>2</sup>	53455	≥200
6	Behaviour after storage on bitumen (28 days / 70°C)	53455	≥±20
	Change in %: Tensile strength	53455	≥±20
	Elongation at break	53455	≥±50
	Modulus of elasticity		

### Dimensional Properties:

#### - Type D waterstops

Figure 1: Typical cross section of type D waterstops

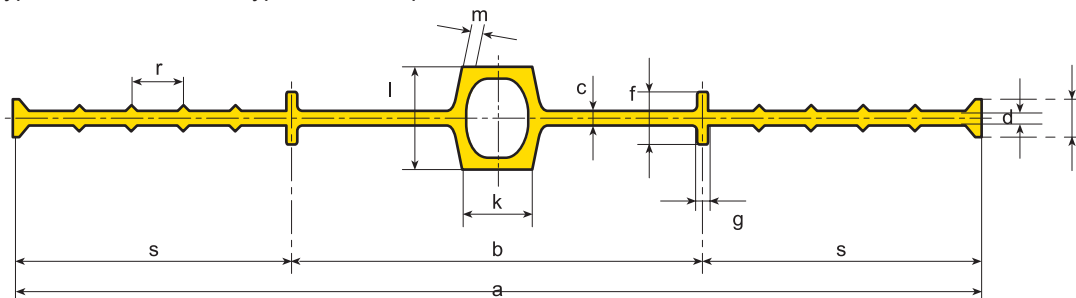

Table 1: Minimum dimensions of type D waterstops

Width			Thickness		Profiling			Channel / Loop		
a	b	s	c	d <sup>1</sup>	f	g	i	k	l	m
190	70	-	2/5	-	15	≥ C	11 ≥ d+6	10	25	3
240	80	62/5	4	3	≥ 3C			20	30	3/5
320	100	75	5	3/5	≥ 3C			20	35	4
500	150	100	6	4/5	18	≥ 3C		45	4/5	

<sup>1)</sup> The thickness of the sealing flanks shall be the same as that of the central web where they meet, but may decrease to *d* at the edges.

#### Key to symbols used in figure 1 and table 1:

- |  |  |
|--|--|
| a. overall width                                 | g. thickness of anchor ribs at the root (tangent intersection) |
| b. width of central web                          | i. thickness of edge reinforcement                             |
| c. thickness of central web at thinnest point    | k. width of channel of loop                                    |
| d. thickness of sealing flanks at thinnest point | l. height of channel or loop                                   |
| f. height of anchor ribs, measured on both sides | m. wall thickness of channel or loop at narrowest point        |

### - Type A waterstops

Figure 2: Typical cross section of type A waterstops

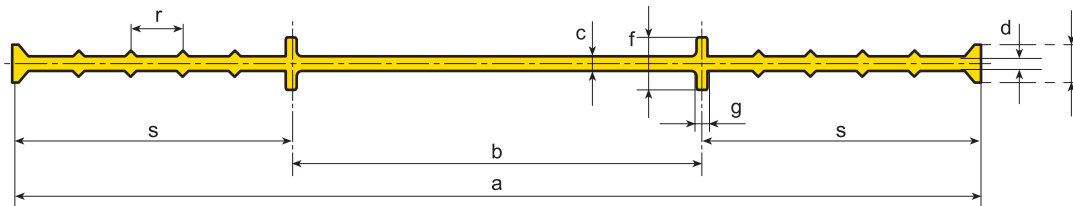

Table 2: Minimum dimensions of type A waterstops

Width			Thickness		Profiling		
a	b	s	c	d <sup>1</sup>	f	g	i
240	80	62/5	3/5	2/5	15	≥ c	11 ≥ d+6
320	100	75	4/5	3	≥ 3c		
500	150	100	6	3/5	18 ≥ 3c		

<sup>1</sup>) The thickness of sealing flanks shall be of the same thickness c as the central web where the two parts meet but may be reduced to d towards the edge.

#### Key to symbols used in figure 2 and table 2:

- a. overall width
- b. width of central web
- c. thickness of central web at thinnest point
- d. thickness of sealing flanks at thinnest point
- f. height of anchor ribs, measured on both sides
- g. thickness of anchor ribs at the root (tangent intersection)
- i. thickness of edge reinforcement

### - Type DA waterstops

Figure 3: Typical cross section of type DA waterstops

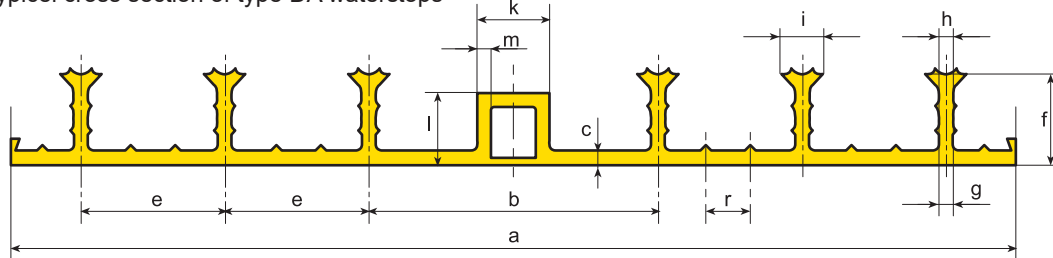

Table 3: Minimum dimensions of type DA waterstops

Width		Thickness	Profiling							Channel / Loop		
a	b	c	N	e	f	f <sub>1</sub> <sup>*</sup>	g	h	i	k	l	m
240	90	4	4	45	20	16	≥ c	4	11 l ≥ h+6	20	20	4
320	100		6		25	21						
500	120		8		25	21						

\* f<sub>1</sub> ≥ f - c

#### Key to symbols used in figure 3 and table 3:

- a. overall width
- b. width of central web
- c. thickness of strip
- e. axial spacing of anchor blocks
- f. height of anchor block
- g. thickness of anchor block at root
- h. thickness of anchor block at narrowest point
- i. thickness of reinforcement at anchor block
- k. width of channel or loop
- l. height of channel or loop
- m. wall thickness of channel or loop at narrowest point
- N. number of anchor blocks
- r. no smaller than 10 mm.



**- Type AA waterstops**

Figure 4: Typical cross section of type AA waterstops

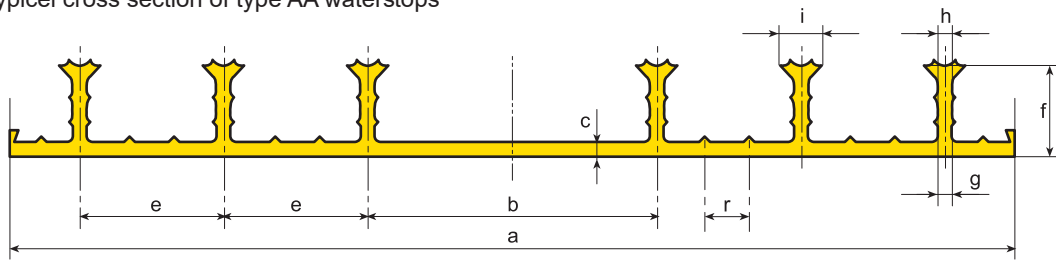

Table 4: Minimum dimensions of type AA waterstops

Width		Thickness	Profiling						
a	b	c	N	e	f	f <sub>1</sub> *	g	h	i
240	90	4	4	45	20	16	$\geq c$ $\geq 0.2 f$	4	11 $\geq h+6$
320	100		6		25	21			
500	120		8		25	21			

\*  $f_1 \geq f - c$

Key to symbols used in figure 3 and table 3:

- a. overall width
- b. width of central web
- c. thickness of strip
- e. axial spacing of anchor blocks
- f. height of anchor block
- g. thickness of anchor block at root
- h. thickness of anchor block at narrowest point
- i. thickness of reinforcement at anchor block
- N. number of anchor blocks
- r. no smaller than 10 mm.

**Waterstop Selection in Accordance with Water Pressure**

According to the EM1110-02-2012 standard (Relate to US Corps of Engineers) P.V.C. waterstop thickness is obtained based on the following chart:

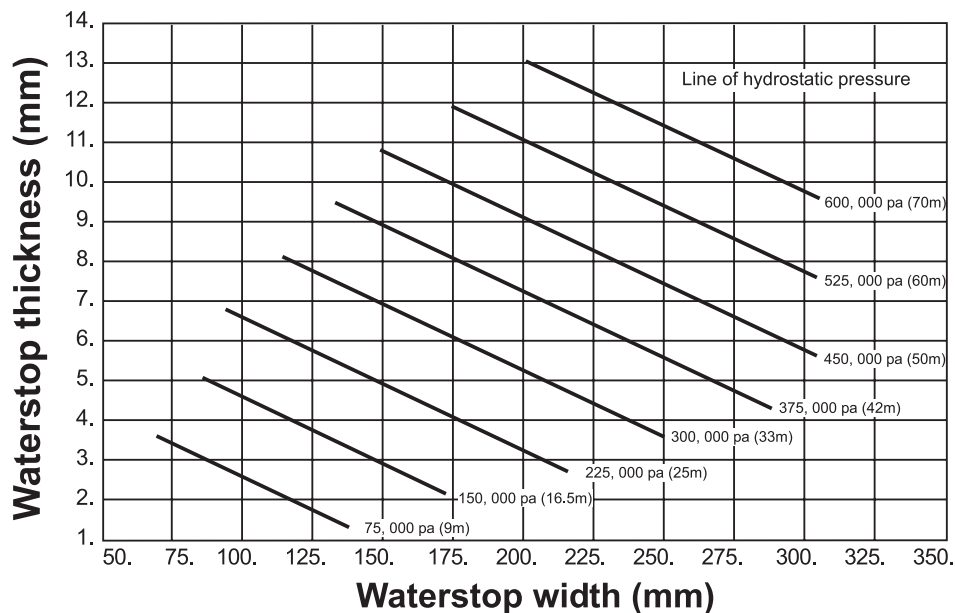

## CAPCO P.V.C. Waterstops

### Waterseal<sup>®</sup> D

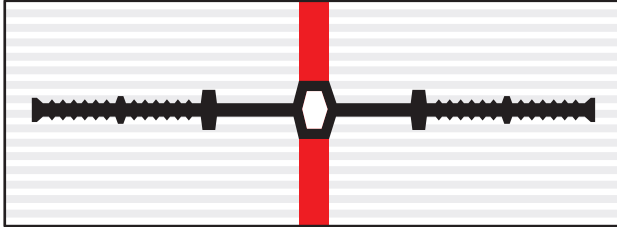

Expansion joint waterstops, internal

Model	Thickness (mm)	Head of Water (m)
Waterseal D150	2.5	8
Waterseal D170	2.5	10
Waterseal D190	2.5	16
Waterseal D240	4	23
Waterseal D300	5	50
Waterseal D300	8	60
Waterseal D320	5	55
Waterseal D400	8	70

### Waterseal<sup>®</sup> A

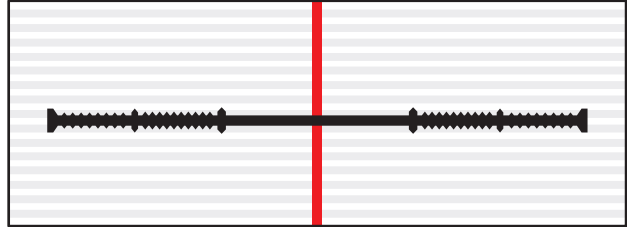

Construction joint waterstops, internal

Model	Thickness (mm)	Head of Water (m)
Waterseal A150	2.5	7.6
Waterseal A170	2.5	10
Waterseal A190	2.5	16
Waterseal A240	3.5	23
Waterseal A300	4	45
Waterseal A320	4.5	50

### Waterseal<sup>®</sup> DA

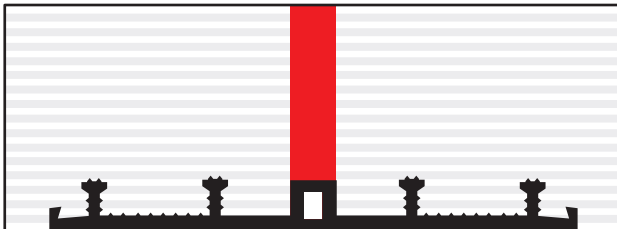

Expansion joint waterstops, external

Model	Thickness (mm)	Head of Water (m)
Waterseal DA 240	4	23
Waterseal DA 300	4	60
Waterseal DA 500	4	80

### Waterseal<sup>®</sup> AA

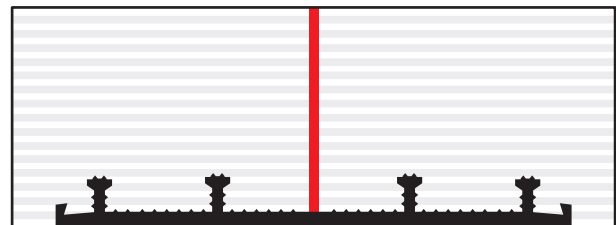

Construction joint waterstops, external

Model	Thickness (mm)	Head of Water (m)
Waterseal AA 240	4	23
Waterseal AA 300	4	50
Waterseal AA 500	4	80

## Tailor-Made Waterstops

P.V.C. waterstop can be manufactured according to customer orders with different dimensions.

## Waterstop Specification

### Design:

#### - Closed Waterproofing System

Waterstops must create a closed waterproofing system within the reinforced concrete structure. Joint intersections with each other and with penetrations and edges of the structure should be made as square as possible. The clearance from the edges of the structure should generally be 0.5 m minimum. The overall waterstop section system specification and method statement for a project are divided into logical sections. These are linked to the drawings of the system and its components, their factory prefabrication or assembly and for their installation on site. This also provides part of the project documentation and confirmation of the specific waterstop qualities required. The waterstops should conform with the local regulations and specifications.

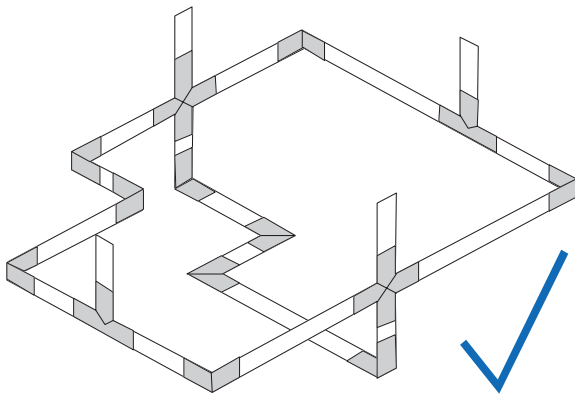

#### - Waterstop Width Rule

The component thickness  $d$  around internal waterstops should be at least equivalent to the waterstop width  $a$  (embedment depth  $\leq$  cover). A component thickness of 300 mm is sufficient for 320 mm wide waterstops according to DIN 18541 (types D and A). The choice of waterstops is based on the load and exposure, e.g. in accordance with DIN V18197. Our Product Engineering department will be pleased to assist you in your projects.

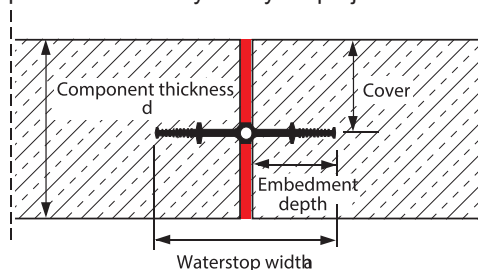

#### - Bending Radius $r$

When there are changes of direction perpendicular to the waterstop level, waterstops may be bended strictly regarding the indicated minimum bending radius  $r$ . If the required bending radius  $r$  cannot be maintained, a factory-made vertical angle should be specified.

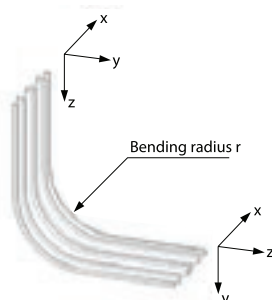

Bending radius $r$	
	$\geq 25$ cm
	$\geq 15$ cm
	$\geq 50 \times$ Stop anchor depth $f$ (Example: $f = 30$ mm $\rightarrow r \geq 1,50$ m)
	$\geq 30 \times$ Profilhöhe $a$ (Example: $a = 70$ mm $\rightarrow r \geq 2,10$ m)
Otherwise	
Mitred angled joint (factory made joint)	

#### - Concrete and Reinforcement Cover

The clearance between waterstop and reinforcement shall be at least 20 mm.

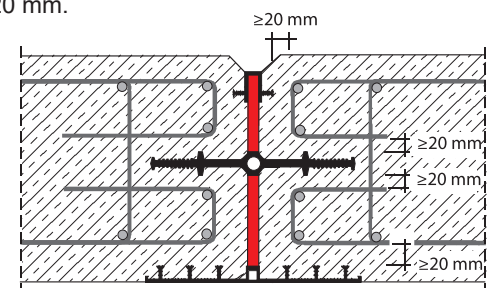

#### - Horizontal Waterstop Installation in Slabs

Internal waterstops in horizontal base or deck slabs should be installed in a v-shape at an angle of about 15° upwards, to allow the waterstop sides to be embedded without voids and to prevent concrete honeycombing (from grout loss / segregation during concreting).

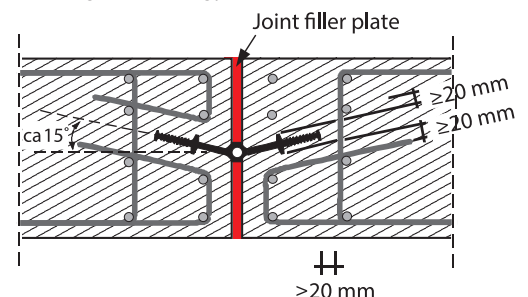

#### - Use of External Waterstops

External waterstops are always fitted on the water contact side. They must not be casted in on the top of horizontal and low angled components (due to the risk of air entrapment and voids). External waterstops must be given adequate durable protection against mechanical damage (e.g. by backfilling with soil, sand, similar fillers without angular crushed stone).

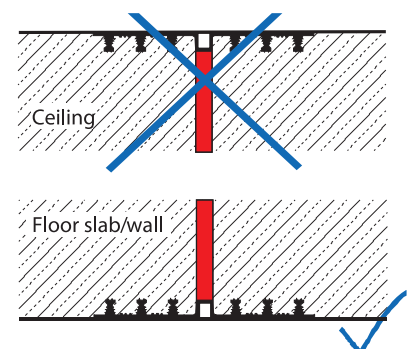

## Waterstop Handling Guidelines

### Storage:

#### - Protected Storage

When delivered to site, the waterstop products must be unloaded carefully and inspected immediately for completeness and integrity, including form and dimensions. Before installation the waterstops must be kept in a sheltered place on boards or some other firm base (e.g. pallets, concrete surfaces) and protected from contamination or damage.

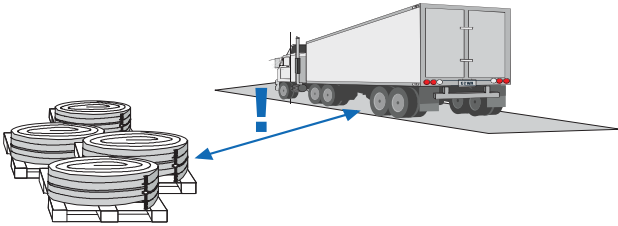

#### - Storage in Summer

Waterstops must be protected from direct sunlight, specially in summer, e.g. by covering. In high outside temperatures waterstops must be taken to the point of installation and laid out under no tension.

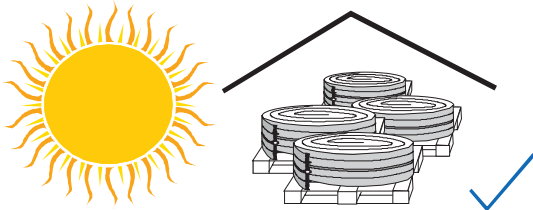

#### - Storage in Winter

Waterstops should be kept in covered storage if possible and then be put in heated rooms for at least one full day prior to their installation, to make their handling and installation easier and less prone to damage (thermoplastic material).

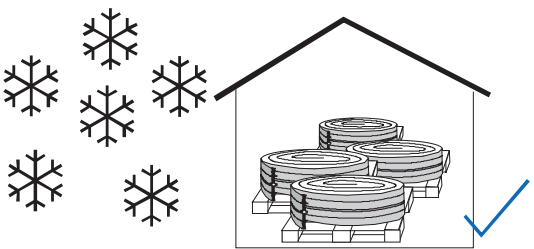

## Waterstop Installation Guidelines

### Installation and Fixing:

#### - Cleanliness and Integrity

Waterstops must not be installed if they have suffered deformation or damage which might impair their function. Waterstops must be installed without creasing or distortion. Deformation in external waterstops caused during storage or handling (e.g. creasing or distortion of the anchors) should be corrected by stretching on a level base and heat treatment. Waterstops can only be installed at a material temperature of over  $\pm 0^{\circ}\text{C}$  and in weather conditions not endangering the safe installation of the whole waterproofing system.

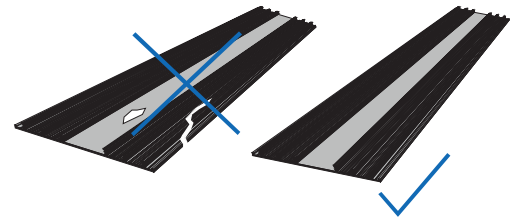

#### - Fixed in a Stable Position

Waterstops should be installed in their specified position, symmetrical to the joint axis, and be fixed so that their position can not change or move during the concreting works.

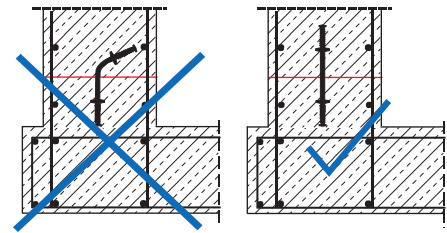

## Waterstop Installation Guidelines on Site

### During the Waterstop Installation:

#### - Fixing Internal Waterstops

Internal waterstops are anchored to the reinforcement. The waterstops are fixed to the edge anchors with the special waterstop clip or, in the case of waterstops with steel plates (FMS, FS) to the edge perforation of the steel plates at maximum intervals of 25 cm.

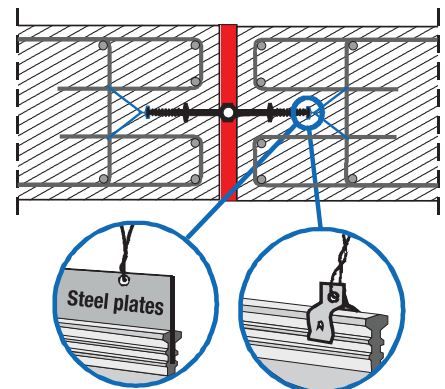

#### - Horizontal Waterstops Positioning in Slabs

To prevent honeycombing or concreting voids, the internal waterstops in bases and decks should be installed in a v-shape at an angle of about  $\geq 15^{\circ}$  upwards.

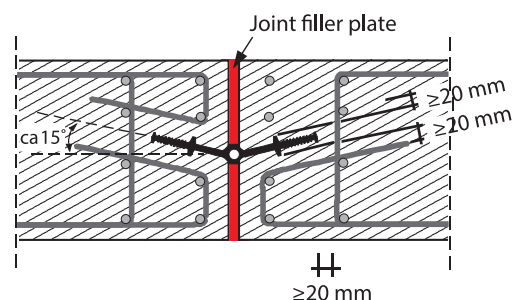

### - Spacing Between Joints in the Waterstops Themselves

The spacing between two joints in the waterstops themselves should be 0.50 m minimum. In every configuration the length of the free waterstop ends should be 1.00 m minimum so that these connection joints can be formed easily and correctly on site.

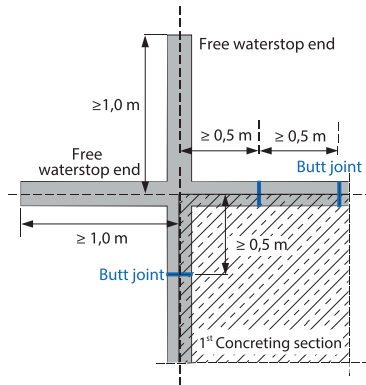

### - Tight Bulkhead Formwork

When installing the waterstop system, ensure that the bulkhead formwork is tight, stable and immovable. The stopend formwork must lie tight against the waterstops. The waterstop must be protected from damage before and during the concreting works.

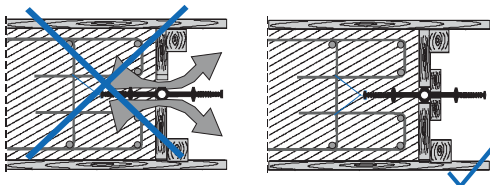

### During the Concreting Works:

#### - Embedding of External Waterstops

Waterstops must be free from contamination and ice when casted in. If necessary they should be cleaned before concreting (e.g. removal of any accumulated site debris such as sawdust, sand, concrete residues, cement laitance, oil, grease, snow, ice etc.). This is particularly important for external waterstops in the base of a structure.

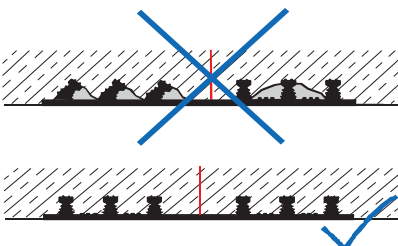

### During the Concreting Works:

#### - Embedding of External Waterstops

Waterstops must be free from contamination and ice when casted in. If necessary they should be cleaned before concreting (e.g. removal of any accumulated site debris such as sawdust, sand, concrete residues, cement laitance, oil, grease, snow, ice etc.). This is particularly important for external waterstops in the base of a structure.

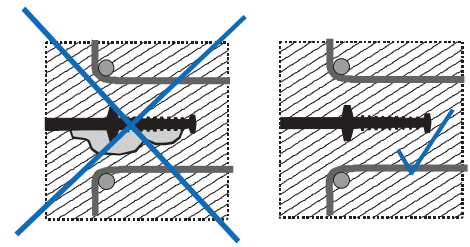

### - Clearance Between Poker Vibrators and Waterstops

The poker vibrators must never touch the waterstop or its fixings (minimum clearance  $\geq 10$  cm). It is usually preferable to compact around external waterstops with external vibrators, which will also give better compaction around stop end anchors.

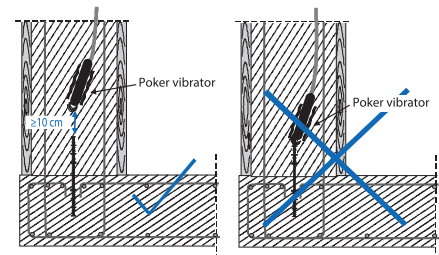

### Protection:

#### - Protection of Exposed Waterstops On Site

The waterstops should be protected from damage until they are fully casted in. Examples of suitable protective measures are:

- For waterstops in walls: cover reinforcement ends with boarding, box in or roll up and suspend the waterstop till later
- For waterstops to be trafficked: completely cover or bed in sand
- For waterstop ends to be exposed for some time: box in to fully protect

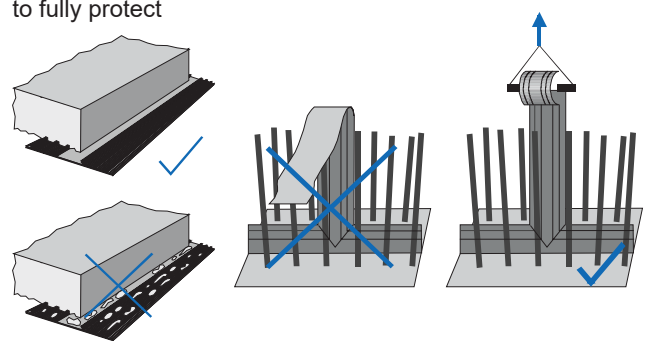

### Striking of Formwork:

#### - Striking Around External Waterstops

Take great care that external waterstops do not come loose during striking of adjacent or attached formwork. Extend the time before striking these areas if necessary.

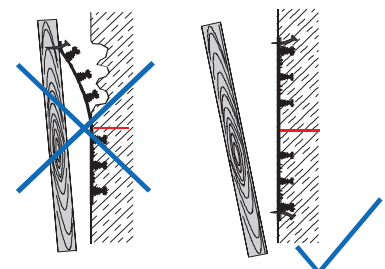

## Waterstops welding



Hot air blower welding procedure



Hot air blower welding tool

Hot air blower teflon plate



Axe-shaped welding procedure



Axe-shaped welding tool

# Hydroseal®

## High Quality Hydrophilic waterstop

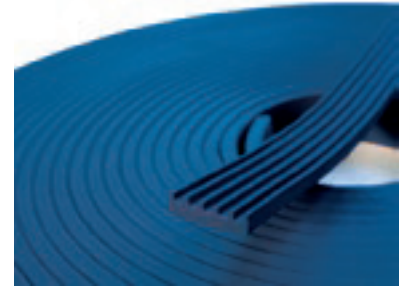

### Description

- Swellable water stop based on synthetic rubber as watertight seal for construction joints with excellent swelling capabilities. Waterseal retains its own form in multiple wet and dry cycles.
- Waterseal has good resistance to a wide range of chemicals – although we would always recommend final confirmation as to suitability in contaminated circumstances be obtained from our technical dept.
- The product remains consistent in its performance throughout its life cycle and the flexibility allows it to fill voids and cracks in the immediate surrounding area.

### Use

- Designed for the easily applied sealing of construction joints in concrete and reinforced concrete construction. Waterseal seals against non-pressing and pressing ground water up to 6 bar. Waterseal can be used in repeated wet and dry cycles.
- The joints should in all instances be square butted and tight to ensure a continuous section with a minimum of 60mm concrete cover.
- Waterseal can be applied both vertically and horizontally but under no circumstances should it be used in expansion joints.

### Application

- Can be mechanically fixed with nails at approx 300mm centres or adhered with adhesive.
- The product can be adhered to concrete, steel and PVC pipe penetrations with the adhesive.
- The adhesive will also ensure a good bond is achieved on slightly uneven surfaces.
- The use of a tying wire around Waterseal in the case of securing it to PVC pipes is also recommended in conjunction with the adhesive.

### SIZES AND PACKAGING

Size	Roll	In a box
20 x 7 mm	15 m	5 x 15 m

### Tailor-Made Waterseal

Hydrophilic waterstop can be manufactured according to customer orders with different dimensions.

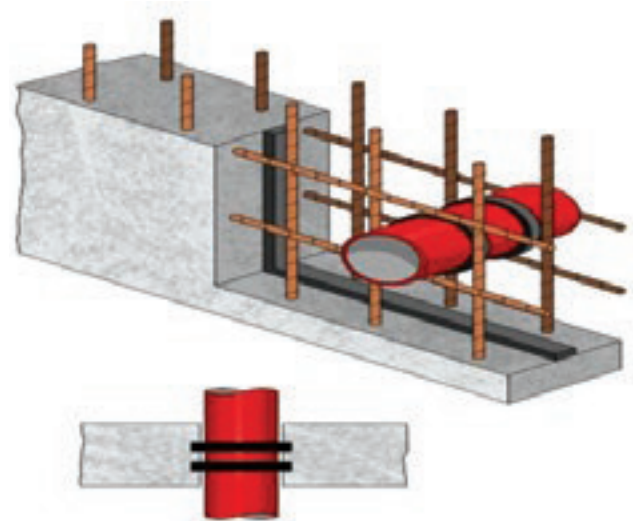

### Technical Data

Swelling capacity in concrete water	400%
Swelling capacity in rain water	500%
Colour	Blue
Hardness	35° Shore A
Tensile strength	>2 MPa
Elongation	>400%
Density	1.22±0.03
Temperature range	-20+75°C
Weather resistance	Excellent
Chemical resistance	Good overall chemical resistance, but we advise to be careful with aromatic oils and fuels, with vegetal oils and strong aromatic solvents. Contact our sales department for detailed specific information.

# Concrete Plastic Accessories

Plastic Spacers

Formwork Special Plastic Pieces

Tunnel and Rail Special Plastic Pieces

Plastic Tools for Special Applications



Concrete Plastic  
Accessories



## Powerchair & Hardchair

Sturdy spacers with clamp, recommended for all heavy-duty loads resist up to 300 kg concentrated load For Hardchair and 450 Kg for Powerchair.

- **Powerchair:** Suitable for very heavy and deep foundations
- **Hardchair:** Suitable for heavy foundation with an average depth



Powerchair



Hardchair

Model	Code	Concrete Cover (mm)	Bar size (mm)	Pcs per Package
Powerchair 50/20-32	4748	50	20-32	250
Powerchair 75/20-32	4749	75	20-32	200

Model	Code	Concrete Cover (mm)	Bar size (mm)	Pcs per Package
Hardchair 30/16-32	818	30	16-32	400
Hardchair 40/16-32	2345	40	16-32	400
Hardchair 50/16-32B	4708	50	16-32	250
Hardchair 50/16-32	2742	50	16-32	250
Hardchair 60/16-32	3027	60	16-32	250
Hardchair 75/16-32C	4746	75	16-32	200
Hardchair 75/16-32B	4707	75	16-32	200
Hardchair 75/16-32	3213	75	16-32	200
Hardchair 100/16-32	3145	100	16-32	200

Pressure-temperature test chart:

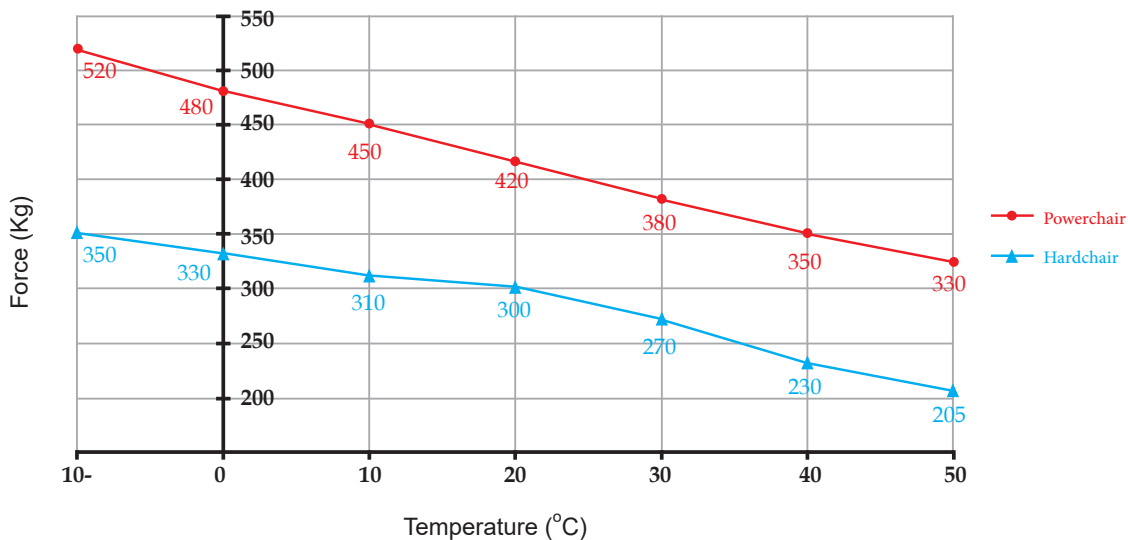

## Maxichair

Sturdy spacer with clamp, recommended for medium to heavy-duty loads resist up to 180 kg concentrated load.



Model	Code	Concrete Cover (mm)	Bar size (mm)	Pcs per Package
Maxichair 15/10-20	650	15	10-20	500
Maxichair 20/10-20	651	20	10-20	500
Maxichair 25/10-20	652	25	10-20	500
Maxichair 30/10-20	653	30	10-20	500
Maxichair 35/10-20	654	35	10-20	500
Maxichair 40/10-20	655	40	10-20	500
Maxichair 50/10-20	656	50	10-20	250
Maxichair 75/10-20	657	75	10-20	250
Maxichair 100/10-20	658	100	10-20	100

Pressure-temperature test chart:

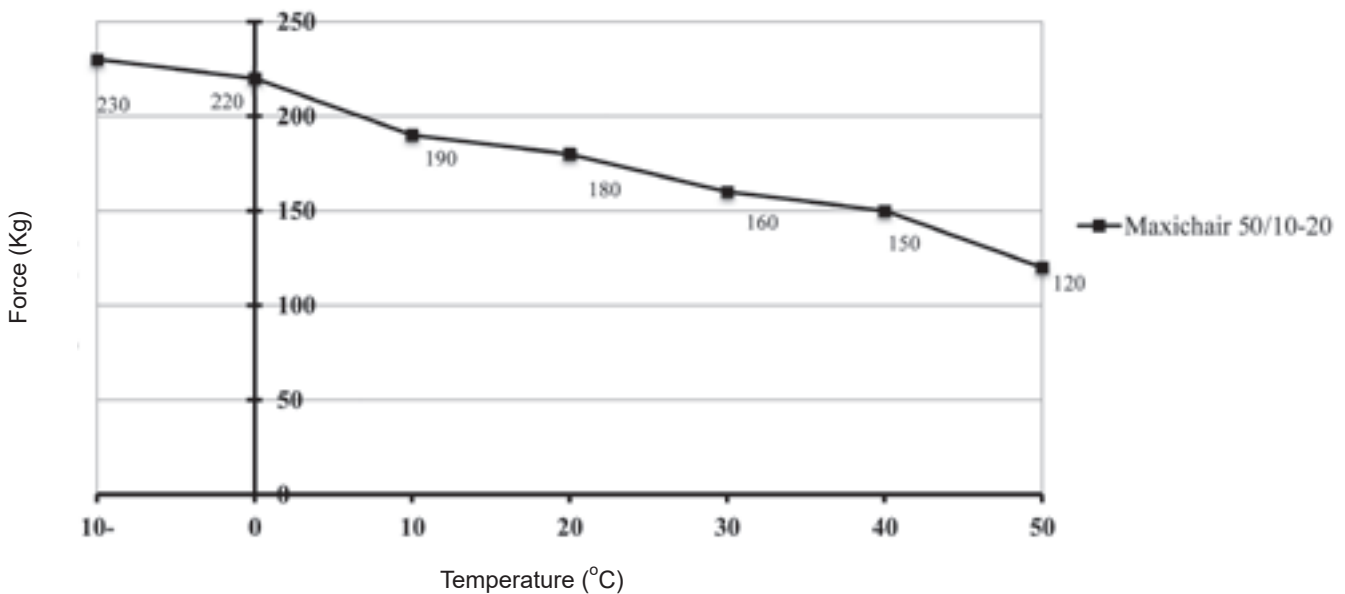

## Fixchair

A User-friendly spacer, suitable for low-duty load resist up to 90 kg concentrated load.

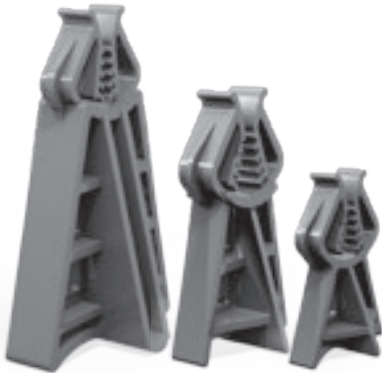

Model	Code	Concrete Cover (mm)	Bar size (mm)	Pcs per Package
Fixchair 15/06-18	3989	15	06-18	2000
Fixchair 20/06-18	716	20	06-18	2000
Fixchair 25/06-18	2983	25	06-18	1000
Fixchair 30/06-18	1725	30	06-18	1000
Fixchair 35/06-18	3301	35	06-18	1000
Fixchair 40/06-18	2998	40	06-18	1000
Fixchair 50/06-18	2999	50	06-18	500
Fixchair 65/06-18	3340	65	06-18	250
Fixchair 75/06-18	3036	75	06-18	250
Fixchair 100/6-18	3236	100	06-18	250
Fixchair 120/6-18	3237	120	06-18	200

Pressure-temperature test chart:

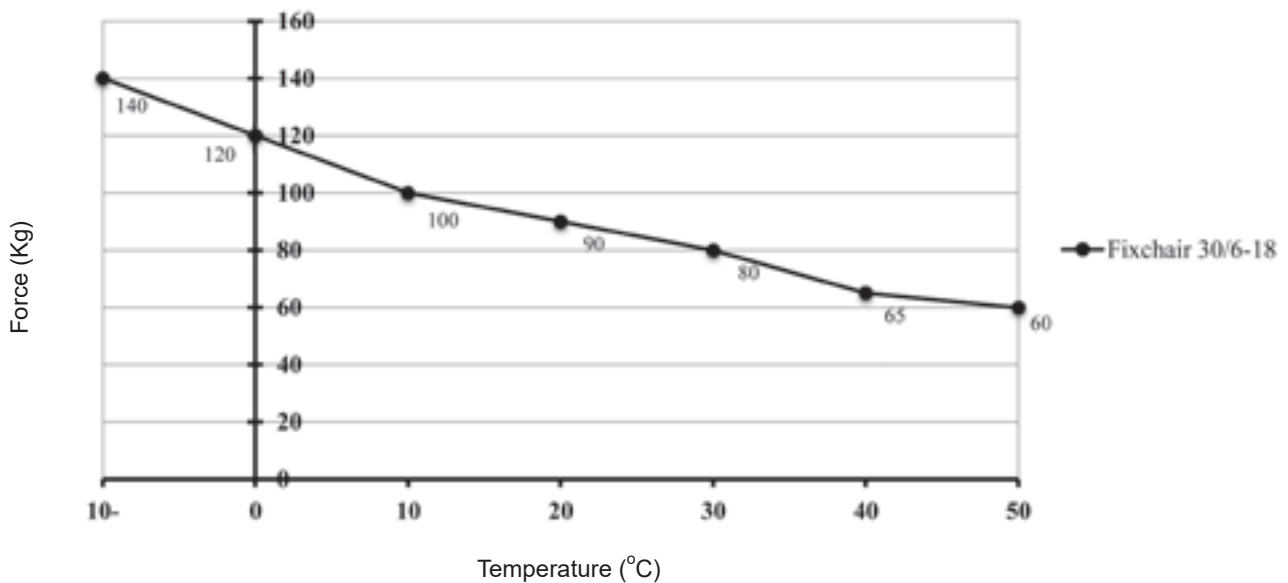

## Sidechair

It is a sturdy clip-on spacer, suitable for medium – duty load slabs

Model	Code	Concrete Cover (mm)	Bar size (mm)	Pcs per Package
Sidechair 30/12-25	1896	30	12-25	1000
Sidechair 40/12-25	3730	40	12-25	1000



## U-chair

Uchair is a sturdy spacer for horizontal reinforcement with a large bar seat

Model	Code	Concrete Cover (mm)	Bar size (mm)	Pcs per Package
U-CHAIR 25	3225	25	any size	1000
U-CHAIR 30	3218	30	any size	1000
U-CHAIR 40	3229	40	any size	500
U-CHAIR 50	3230	50	any size	500



## Keepchair

It is a sturdy clip-on spacer for medium and lower reinforcement layer which can be applied in cast in place and precast concretes

Model	Code	Concrete Cover (mm)	Bar size (mm)	Pcs per Package
Keepchair 30/04-14	3731	30	04-14	1000
Keepchair 40/04-14	2535	40	04-14	1000



## Multichair

It is a sturdy spacer with four-load Clamp; perfectly suitable for use at crossing point

Model	Code	Concrete Cover (mm)	Bar size (mm)	Pcs per Package
Multichair 25/08-16	--	25	08-16	500
Multichair 30/08-16	--	30	08-16	500



## Echochair

Sturdy clip-on spacer for medium reinforcement especially for precast concrete

Model	Code	Concrete Cover (mm)	Bar size (mm)	Pcs per Package
Ecochair 25/06-08	---	25	06-08	1000
Ecochair 25/08-12	---	25	06-12	1000
Ecochair 30/06-08	3983	30	06-08	1000
Ecochair 30/08-12	---	30	06-12	1000



## Roundchair

Round chair is a kind of ring spacer for supporting large area. It is extremely sturdy and tilt-resistance due to protruding webs.

Model	Code	Concrete Cover (mm)	Bar size (mm)	Pcs per Package
Roundchair 20	3635	20	300	100
Roundchair 25	3433	25	300	100
Roundchair 30	3434	30	300	100



## Longchair

Plastic spacer with high-load bearing capacity with coupling for jointing purpose

Model	Code	Concrete Cover (mm)	Length (mm)	Pcs per Package
Longchair 25	2204	25	250	1000
Longchair 30	2205	30	250	1000
Longchair 40	2206	40	250	500
Longchair 50	2210	50	250	500



## Easychair

Reasonably priced spacer for horizontal reinforcement, supporting large roof and floor areas

Model	Code	Concrete Cover (mm)	Length (mm)	Pcs per Package
Easychair 20	3342	20	250	200
Easychair 20 S	3813	20	190	200
Easychair 25	3343	25	250	200
Easychair 30	3344	30	250	150



## Polychair

Polychair is an especial spacer suitable for durable mesh application. It provides 25-30 mm concrete cover for bottom and 90-150 mm for upper bars.

Model	Code	Lower Mesh	Upper Mesh	Pcs per Package
Polychair 25/30-75 to 150	---	25/30	65-150	100
Polychair 30/40-75 to 150	---	30-40	65-150	100



## Platebar

It is a suitable spacer for soft ground and plate bar frameworks

Model	Code	1 (Cover)	2 (Cover)	Bar size (mm)	Pcs per Package
Platebar 25/30-08-14	670	25	30	08-14	250
Platebar 40/50-08-14	671	40	50	08-14	250
Platebar 60/70-08-14	4699	60	70	08-14	250



## Pyramid

It is a unique piece that can be replaced with reinforcement standee.

This product is strong and stable; also it is suitable for mesh networks with high thickness.

Model	Code	Concrete Cover (mm)	Bar size (mm)	Pcs per Package
Pyramid 190/10-12	3323	190	10-12	100
Pyramid 260/10-12	3324	260	10-12	75



## Fixplate

It is kind of spacer for soft ground or insulation, waterproof membranes or grand floor slabs. The large base area prevents any puncturing.

Model	Code	Concrete Cover (mm)	Bar size (mm)	Pcs per Package
Fixplate 20/06-18	4247	20	06-18	1000
Fixplate 25/06-18	4238	25	06-18	1000
Fixplate 30/06-18	4239	30	06-18	1000
Fixplate 35/06-18	4240	35	06-18	1000
Fixplate 40/06-18	4241	40	06-18	500
Fixplate 50/06-18	4242	50	06-18	500



## Cagebar

Cagebar is applied especially for reinforcement cages for pile foundation and bridge in closed and open (with clip) design. It supports lowering of the reinforcement cage and ensures correct concrete cover.

Model	Code	Concrete Cover (mm)	Bar size (mm)	Pcs per Package
Cagebar O75	700	75	14	50
Cagebar O100	4701	100	14-16	50
Cagebar V75	701	75	14-16	50



Cagebar O



Cagebar V

## Parafix

Type M: Concrete joists spacer for metal form

Type F: Concrete joists spacer for permanent form

Model	Code	Concrete Cover (mm)	Bar size (mm)	Pcs per Package
Parafix M15/06-18	4544	15	06-18	1000
Parafix M4-15/12-18	4628	15	12-18	1000
Parafix F12/06-10	4545	12	06-10	1000



M



F



M4

## Wallfix

Wallfix is designed for vertical formwork where fix distance between reinforcement and formwork is required. It is suitable for walls and vertical applications such as shear walls.

Model	Code	Concrete Cover (mm)	Bar size (mm)	Pcs per Package
Wallfix 190-30/04-14	1978	30	04-14	250
Wallfix 200-25/06-08	---	25	06-08	250
Wallfix 300-30/04-14	701	30	04-14	250



## Wheelsun

Wheelsun is a circular spacer which is designed for vertical reinforcement, that is suitable for walls and columns. It can be used for numerous bar diameters.

Model	Code	Concrete Cover (mm)	Bar size (mm)	Pcs per Package
Wheelsun 20/04-08	3749	20	04-08	1000
Wheelsun 20/08-14	3750	20	08-14	1000
Wheelsun 25/04-08	3751	25	04-08	1000
Wheelsun 25/08-12	3752	25	08-12	1000
Wheelsun 30/04-08	3753	30	04-08	500
Wheelsun 30/08-12	3754	30	08-12	500



## Wheelbar

Wheelbar is a proven spacer for universal use, clamping tongues for several bar diameters. Enlarged support increases tilting resistance.

Model	Code	Concrete Cover (mm)	Bar size (mm)	Pcs per Package
Wheelbar 15/04-08	610	15	04-08	2000
Wheelbar 15/08-12	---	15	08-12	2000
Wheelbar 15/10-14	612	15	10-14	2000
Wheelbar 20/04-08	613	20	04-08	2000
Wheelbar 20/10-14	615	20	10-14	1000
Wheelbar 25/04-08	616	25	04-08	1000
Wheelbar 25/10-14	617	25	10-14	500
Wheelbar 30/06-10	3003	30	06-10	500
Wheelbar 30/08-14	2979	30	08-14	500
Wheelbar 30/14-20	857	30	14-20	500
Wheelbar 35/08-14	3430	35	08-14	500
Wheelbar 35/14-20	3414	35	14-20	250
Wheelbar 40/08-14	2754	40	08-14	250
Wheelbar 40/10-20	2755	40	10-20	250
Wheelbar 45/08-14	626	45	08-14	250
Wheelbar 45/14-20	3412	45	14-20	250
Wheelbar 50/08-14	3122	50	08-14	200
Wheelbar 50/10-20	3121	50	10-20	200
Wheelbar 50/20-30	635	50	20-30	150
Wheelbar 65/08-14	4036	65	08-14	150
Wheelbar 75/08-16	3023	75	08-16	75
Wheelbar 75/16-32	2733	75	16-32	75
Wheelbar 100/16-32	634	100	16-32	50

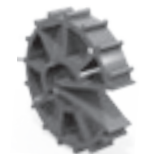

## Spacer Layout in Vertical Structures

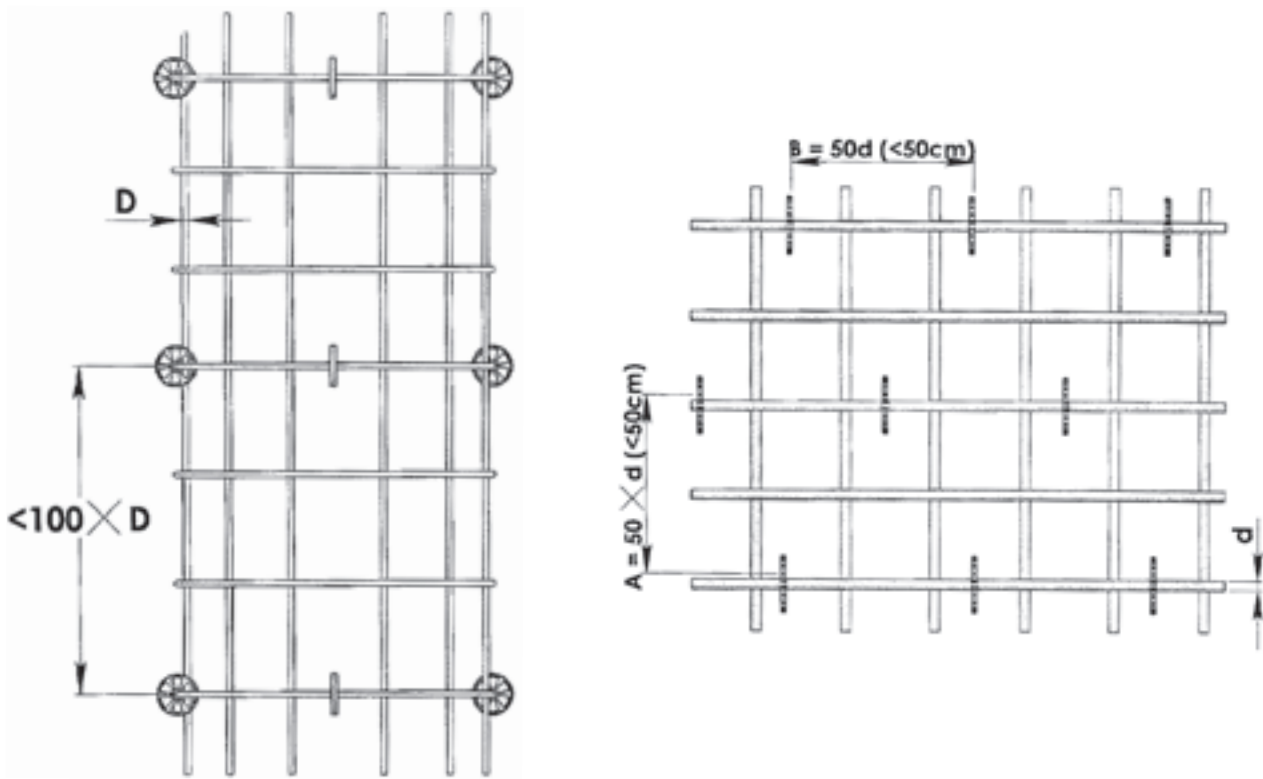

## Spacer layout in Horizontal Structures

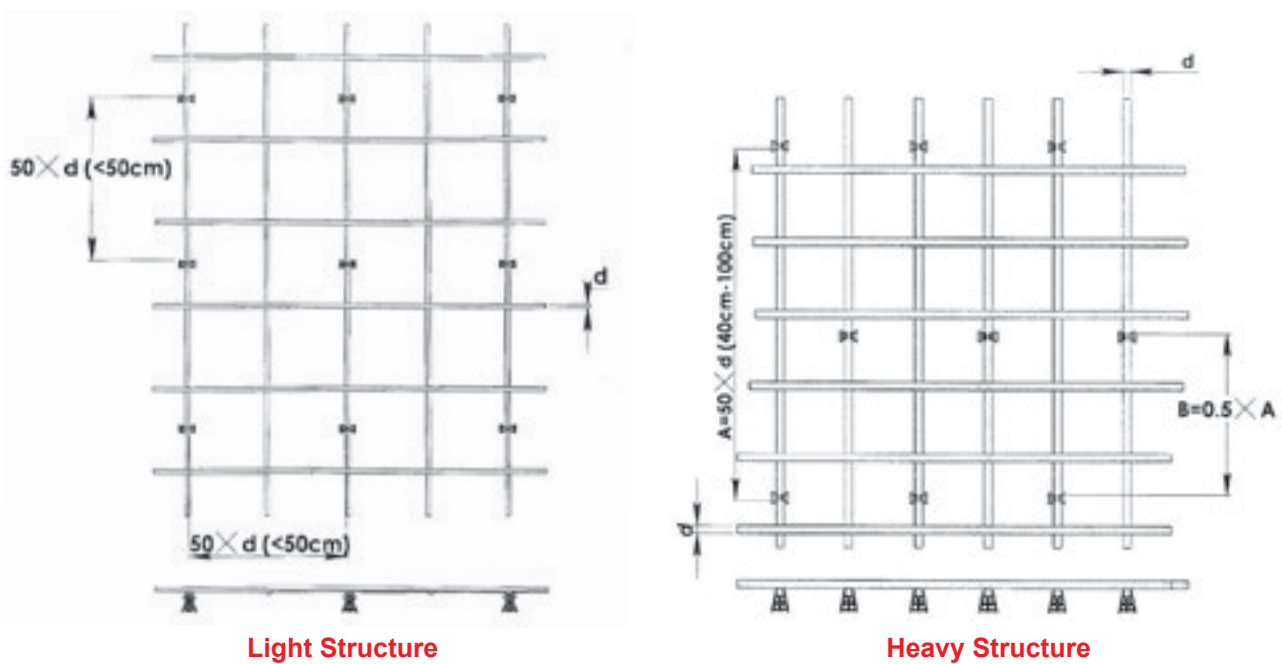



## Coverbolt

Coverbolt is a standard spacer for waterproofing application between walls. It has a suitable contact with concrete and rapidly increases work. It is made by P.V.C materials that prevent chemical reaction.

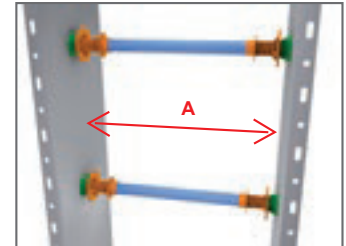

Model	S Code	Pcs per S Package	L Code	Pcs per L Package	A (cm)
Coverbolt 20	1866	80	2132	80	20 cm
Coverbolt 25	1867	80	2133	80	25 cm
Coverbolt 30	1308	40	1970	40	30 cm
Coverbolt 35	1878	40	1971	40	35 cm
Coverbolt 40	1514	40	1955	40	40 cm

## Sleeve

Right solution to transfer bolt and adjust the distance between non-waterproofing walls.

Model	Code	Length (cm)	Pcs per Package
Sleeve 20	4095	20	160
Sleeve 25	4096	25	160
Sleeve 30	4097	30	80
Sleeve 35	4098	35	80
Sleeve 40	4099	40	80
Sleeve 50	4100	50	80



## Confix

It is a plastic plug for filling redundant holes.

Model	Code	A (mm)	B (mm)	Pcs per Package
Conefix	2714	30	20	1000

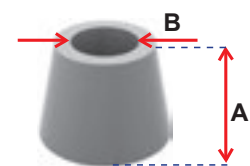

## Conepipe

It is a part of coverbolt and placed on either side of it.

Model	Code	A (mm)	B (mm)	Pcs per Package
Conepipe 22/10	711	10	22	1000
Conepipe 22/20	---	20	22	1000
Conepipe 22/40	713	40	22	500
Conepipe 26/10 L	3136	10	26	1000
Conepipe 26/10 S	712	10	26	500

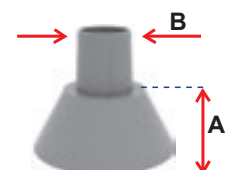

## Pipe

A transfer tuskier pipe solution with a length of 3m.



## Endfix

It is a part of coverbolt and placed on either side of it.

Model	Code	A (mm)	Bar size (mm)	Pcs per Package
Endfix S 22	695	20	22	500
Endfix L 22	696	40	22	250

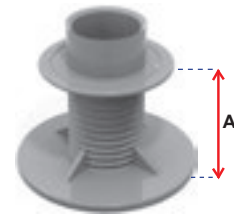

## Stopper

Stopper with a variety of sizes and resilient material is suitable for sealing inside Coverbolt Pipe.

Model	Code	size (mm)	Pcs per Package
Stopper U 22	1304	22	500
Stopper T 22	1306	22	500
Stopper R 22	1397	22	500
Stopper W 22	1519	22	500



## Goveh

It is made of sturdy plastic material, with a high load of capacity, dimensionally stable, and rot-proof.

Model	Code	A (mm)	B (mm)	Pcs per Package
Goveh 50/12	---	50	12	1000
Goveh 75/12	3987	75	12	1000
Goveh 115/16	3986	115	16	1000

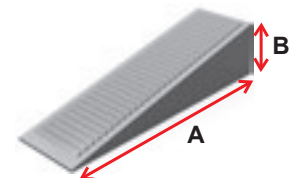

## Nalshim

It is a plug for distance plate which cover rebars and provides arbitrary space around the bars. It is a recommended for precast concrete.

Model	Code	A (mm)	B (mm)	Pcs per Package
Nalshim 50/1	3539	50	1	1000
Nalshim 50/2	3540	50	2	1000
Nalshim 50/3	3541	50	3	1000
Nalshim 50/5	3542	50	5	1000
Nalshim 50/10	3543	50	10	1000
Nalshim 100/1	3544	100	1	1000
Nalshim 100/2	3545	100	2	1000
Nalshim 100/3	3546	100	3	1000
Nalshim 100/5	3547	100	5	1000
Nalshim 100/10	3548	100	10	1000

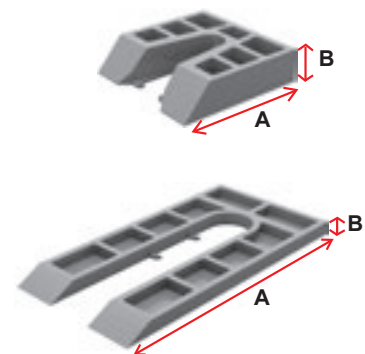

## Stopin

Stopin is made from resilient materials to fill the formwork holes.

Model	Code	size (mm)	Pcs per Package
Stopin	2219	17	1000



## Shim, Holeshim, & Hourseshim

It is a reasonably priced plug for distance plate. In order to reach greater heights perforated shims can be stacked. Small pins and matching holes prevent the perforated shims from slipping and ensure a good band.

Model	Code	Length (mm)	Thickness (mm)	Pcs per Package
Shim 70/1	-----	70	1	1500
Shim 70/2	-----	70	2	1500
Shim 70/3	-----	70	3	1500
Shim 70/5	-----	70	5	1000
Shim 70/10	-----	70	10	1000
Holeshim 80/1	-----	80	1	1500
Holeshim 80/2	-----	80	2	1500
Holeshim 80/3	-----	80	3	1500
Holeshim 80/5	-----	80	5	1000
Holeshim 80/10	-----	80	10	1000
Hourseshim 2	-----	70	2	1000
Hourseshim 3	-----	70	3	1000
Hourseshim 5	-----	70	5	1000
Hourseshim 10	-----	70	10	1000



## Switchbox

Switchbox is an installed electrical outlet box in concrete structures. It is anti-seepage liquid

Model	Code	A (mm)	B (mm)	Pcs per Package
Switchbox 5	3818	50	60	150
Switchbox 8	3620	80	60	150

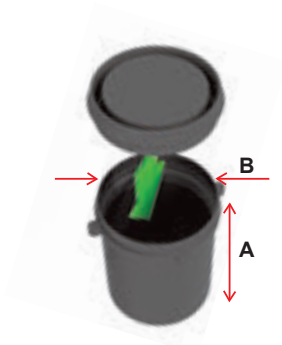

Down Side



Door



Body

Model	Code	High (mm)	Thickness (mm)	Pcs per Package
Switchbox 6	3903	60	65	150
Switchbox 4	3902	45	60	150

## Connector

It is a suitable accessory to divide the electrical cables in concrete structures.



## Pad Rail

It is a suitable plastic piece for the temporary tracklayer in tunnels.



## Rawlplug

It is a Buried plastic piece in traversing to fasten the rail on traverse.



## Plaque

It is a Buried plastic piece in traversing that traverse information is recorded on it.



## Plastit insert

They are plastic pieces to connect the concrete segments in TBM systems.



Sofix



Conex

## Lifting Socket

It is a plastic accessory for Lifting and transporting concrete segments.



## Protector

It is a flexible plastic piece to protect the bottom of the electrical transmission system at the time of concreting.

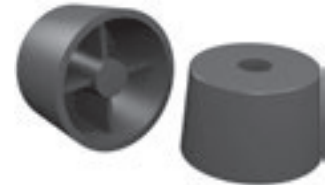

## Nailfix

Nailfix is designed to uniform all created spaces between Anchor Bolt and soil.

Model	Code	Concrete Cover (mm)	Bar size (mm)	Pcs per Package
Nailfix20	3227	20	32	100
Nailfix30	4693	30	32	100



## Strandfix

It is a suitable plastic accessory for strand cable assembly for consolidating the mountains, dam and bridge construction.

Model	Code	Diameter (mm)	Pcs per Package
Strandfix	4511	90	250



## Capbar

It is a safety cap plugging end of bars; to keep safety of workers in work place environment. Distinct color helps being visible easily.

Model	Code	Bar size (mm)	Pcs per Package
Capbar 8-12	4513	8-12	500
Capbar 12-16	4514	12-16	500
Capbar 16-24	4515	16-24	500
Capbar 16-32	960	16-32	250



## Headbar

It is designed to prevent any corrosion for rebar end. Tight fitting into reinforcement bars and reduce formwork contact.

Model	Code	Bar size (mm)	Pcs per Package
Headbar 30/12-18	2217	12-18	500



## Ductbank

It is a cost effective space holder for preventing flotation during concrete pour.

Model	Code	Concrete Cover (mm)	Bar size (mm)	Pcs per Package
Ductbank /110	1908	4	110	25
Ductbank /160	4300	6	160	10



## T Plus

Tile spacers are used for tiling and bricklaying. They are used to install joint and they ensure precision. T plus spacers are used as an assembly aid when laying tiles, slabs, hard bricks and floor elements.

Model	Code	A (mm)	Pcs per Package
+2	2053	2	200
+3	2054	3	200
+4	2055	4	200
+5	2056	5	200
+6	2057	6	200
+7	2058	7	200
+8	2059	8	200
+10	2060	10	200
T2	1905	2	200
T3	2010	3	200
T4	2011	4	200
T5	2012	5	200
T7	2013	7	200
T8	2061	8	200
T10	2062	10	200

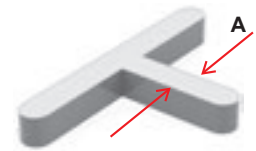

## Rooftile

Roof tile spacer provides equal height and joint at the erection of the square tiles laid over the insulating materials at open roofs to protect them against natural conditions.

Model	Code	outer diameter (mm)	Height (mm)	Pcs per Package
Roof Tile Spacer	4676	150	13	100



## Foamfix

It is a suitable accessory for fixing polystyrene foam for isolation of surfaces.

Model	Code	End diameter (mm)	Length (mm)	Pcs per Package
Foamfix	-----	60	110	500

